



MarkVCID2 Clinical Assessments Worksheets

Version 7.15.25
MarkVCID Consortium

By the MarkVCID Clinical & Cognitive Subcommittee (Deborah Blacker, MD, SCD, Chair, and Coordinating Center PI Steven M. Greenberg, MD, PhD).

Based in substantial part on the Uniform Data Set 3.0 of the National Alzheimer's Coordinating Center. Reproduced with permission. Copyright 2006, 2008, 2015, 2017 University of Washington. Created and published by the ADC Clinical Task Force (John C. Morris, MD, Chair) and the National Alzheimer's Coordinating Center (U01 AG 016976 – Walter A. Kukull, PhD, Director).

The MarkVCID Consortium is funded by the National Institutes of Health through the National Institute of Neurological Disorders and Stroke and National Institute on Aging (Cooperative Agreement U24NS100591).

MarkVCID2 Clinical Assessments Worksheets

Table of Contents

MoCA Worksheet	3
Verbal Fluency – F-Word Worksheet	4
Craft Story 21 Recall (Immediate) Worksheets	6
Number Span Test (Forward & Backward) Instructions & Worksheets	9
Category Fluency Worksheets	11
Trail Making A & B Worksheets	13
Multilingual Naming Test (MINT) Worksheets	19
Craft Story 21 Recall (Delayed) Worksheets	53
Word List Learning with Immediate/Delay/Recognition Worksheets	56
Brief Co-participant/Informant Questionnaire	57
Clinical Dementia Rating Instructions & Worksheets	58
CDR (CLINICAL DEMENTIA RATING)	58
Geriatric Depression Scale (GDS) Worksheet.....	60
Measurement of Everyday Cognition Short Form (ECog-12) Participant Self Report Worksheet	61
Measurement of Everyday Cognition Short Form (ECog-12) Informant Worksheet	62
Neuropsychiatric Inventory-Questionnaire (NPI-Q) Informant Assessment Worksheet	63
NACC Functional Assessment Scale (FAS) Informant Assessment Worksheet	65

Based in substantial part on the Uniform Data Set 3.0 Neuropsychological Battery of the National Alzheimer's Coordinating Center. Reproduced with Permission. Copyright 2006, 2008, 2015, 2017 University of Washington. Created and published by the ADC Clinical Task Force Copyright© 2006, 2008, 2015 University of Washington. Created and published by the ADC Clinical Task Force (John C. Morris, MD, Chair) and the National Alzheimer's Coordinating Center (U01 AG 016976 - Walter A. Kukull, PhD, Director).

The MarkVCID Consortium is funded by the National Institutes of Health through the National Institute of Neurological Disorders and Stroke and National Institute on Aging (Cooperative Agreement U24NS100591)

**Before using these worksheets, please read the
MarkVCID Evaluator's Instructions Manual for Clinical Assessments.**

MoCA Worksheet

Corresponds with NACC Form C2 Neuropsychological Battery Scores (UDS 3)

Subject ID _____ Date ____/____/____ Examiner's initials _____

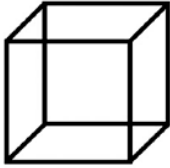
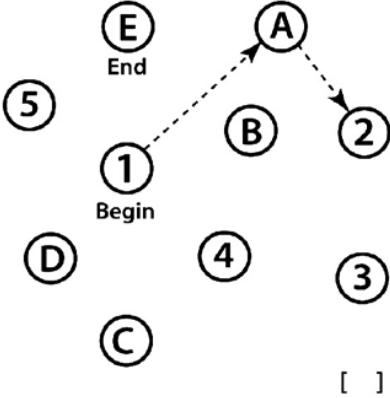
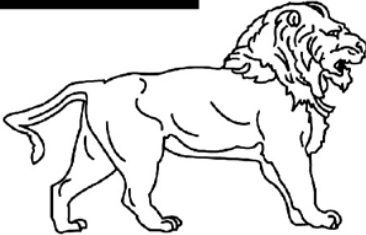
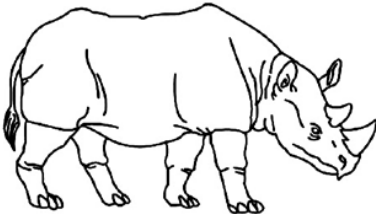
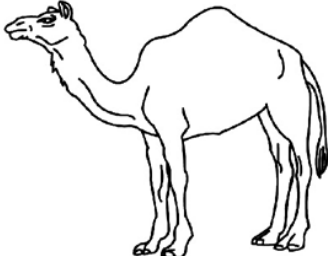
VISUOSPATIAL / EXECUTIVE			Copy cube	Draw CLOCK (Ten past eleven) (3 points)	POINTS			
	[]	[]	[]	[]	[]			
		Contour	Numbers	Hands	___/5			
NAMING					___/3			
MEMORY		Read list of words, subject must repeat them. Do 2 trials, even if 1st trial is successful. Do a recall after 5 minutes.	FACE	VELVET	CHURCH	DAISY	RED	No points
		1st trial						
		2nd trial						
ATTENTION		Read list of digits (1 digit/ sec.).	Subject has to repeat them in the forward order		[] 2 1 8 5 4			___/2
			Subject has to repeat them in the backward order		[] 7 4 2			
		Read list of letters. The subject must tap with his hand at each letter A. No points if ≥ 2 errors	[] FBACMNAAJKLBAFAKDEAAAJAMOF AAB					___/1
		Serial 7 subtraction starting at 100	[] 93	[] 86	[] 79	[] 72	[] 65	___/3
		4 or 5 correct subtractions: 3 pts , 2 or 3 correct: 2 pts , 1 correct: 1 pt , 0 correct: 0 pt						
LANGUAGE		Repeat: I only know that John is the one to help today. []						___/2
		The cat always hid under the couch when dogs were in the room. []						
		Fluency / Name maximum number of words in one minute that begin with the letter F [] ____ (N ≥ 11 words)						___/1
ABSTRACTION		Similarity between e.g. banana - orange = fruit [] train - bicycle [] watch - ruler						___/2
DELAYED RECALL		Has to recall words WITH NO CUE	FACE []	VELVET []	CHURCH []	DAISY []	RED []	Points for UNCUED recall only
Optional		Category cue						
		Multiple choice cue						
ORIENTATION		[] Date	[] Month	[] Year	[] Day	[] Place	[] City	___/6
© Z.Nasreddine MD		www.mocatest.org		Normal ≥ 26 / 30		TOTAL		___/30
		Add 1 point if ≤ 12 yr edu						

©Ziad Nasreddine MD 2004. MoCA® is a registered trademark property of Neurosearch Développements Inc. and is used under license. Form created as part of the National Alzheimer's Coordinating Center Uniform Data Set, copyright 2013 University of Washington.

Insert the score for each item in the MarkVCID e-Case Report Form MoCA (Montreal Cognitive Assessment)

Rules for single-item scoring and index score calculations for the MoCA*

ITEMS	Points towards total score	Memory***	INDEX SCORES				
			Executive	Attention/ concentration	Language	Visuospatial	Orientation
Trails	1	–	1	–	–	–	–
Cube	1	–	–	–	–	1	–
Clock Circle	1	–	1	–	–	1	–
Clock Hands	1	–	1	–	–	1	–
Clock Time	1	–	1	–	–	1	–
Language Naming	3	–	–	–	3	3	–
Memory: Registration (2 learning trials, total possible = 10)	0, not scored	–	–	Immediate recall, 2 trials total, max=10	–	–	–
Attention: Digits	2	–	2	2	–	–	–
Attention: Letter A	1	–	1	1	–	–	–
Attention: Serial 7s	3	–	3	3	–	–	–
Language: Repetition	2	–	–	2	2	–	–
Language: Fluency	1	–	1	–	1	–	–
Abstraction	2	–	2	–	–	–	–
Delayed Recall with no cue	5	=3x number words recalled freely (max=15)	–	–	–	–	–
Delayed Recall with category cue	0**	=2x number of words retrieved with category cue (max=10)	–	–	–	–	–
Delayed Recall, recognition	0**	=1x number of words recognized (max=5)	–	–	–	–	–
Orientation: date	1	–	–	–	–	–	1
Orientation: month	1	–	–	–	–	–	1
Orientation: year	1	–	–	–	–	–	1
Orientation: day	1	–	–	–	–	–	1
Orientation: place (name)	1	–	–	–	–	–	1
Orientation: city	1	–	–	–	–	–	1
Totals	30	15	13	18	6	7	6

*©Ziad Nasreddine MD 2004. MoCA® is a registered trademark property of Neurosearch Développements Inc. and is used under license. Form created as part of the National Alzheimer's Coordinating Center Uniform Data Set, copyright 2013 University of Washington.

**The standard administration of the MoCA does not score category and recognition responses, even if administered.

***If all five words are freely recalled, then cued and category recall are not administered and the total score would be 15 (3 points for each word recalled). After free recall, category cues are given *only for items not recalled*. Each word correct with category cue is awarded 2 points. After category cues, only words not correct are then tested with recognition. Award 1 point for each word correct on recognition (max=5).

Craft Story 21 Recall (Immediate) Worksheets

Corresponds with NACC Form C2 Neuropsychological Battery Scores (UDS 3)

Subject ID _____ Date ____/____/____ Examinee's initials _____

INSTRUCTIONS: Making sure you have the participant's attention and read the following instructions aloud. Then read the story slowly, articulating clearly and with normal inflection.

SAY: "I am going to read you a story. Listen carefully, and when I am through, I want you to tell me everything you can remember. Try to use the same words I use but you may also use your own words. The story is ..."

Maria's / child / Ricky / played / soccer / every / Monday /

at 3:30. / He / liked / going / to the field / behind / their / house /

and joining / the game. / One / day, / he / kicked / the ball / so / hard /

that it / went / over / the neighbor's / fence / where three / large /

dogs / lived. / the dogs' / owner / heard / loud / barking, / came /

out, / and helped / them / retrieve / the ball.

Record time administration ended:

Total story units recalled (VERBATIM SCORING): _____ / 44

Total story units recalled (PARAPHRASE SCORING): _____ / 25

Insert the score in the MarkVCID e-Case Report Form NP Testing Battery #1b,c Craft Story 21 recall (immediate)

As soon as the story is over, give the recall instruction:

SAY: "Now tell me the story I just told you. Try to remember as much as you can."

Record the participant's recall, writing between the lines of the story above. For rapid and accurate transcribing of the story, use abbreviations as needed, omit filler words and irrelevant verbiage, and if absolutely necessary, say "A little slower, please," rather than miss story elements. Make sure your transcription of the story is legible before proceeding.

After transcribing the story, you must give the delayed recall cue.

SAY: "Later on, I will ask you to tell me this story again, so try not to forget it." Note the time so that later you can calculate the time that has elapsed between Craft Story 21 Recall (Immediate) test and the Craft Story 21 Recall (delayed) test.

Reproduced by permission of the author, Suzanne Craft, PhD; do not copy or distribute without author's permission. Form created as part of the Uniform Data Set of the National Alzheimer's Coordinating Center, copyright ©2013 University of Washington.

Craft Story 21 RECALL (Immediate): Verbatim SCORING

PERFECT VERBATIM RESPONSE (1.0 POINT): Give the subject 1 point for every part for which content words are recalled exactly and completely. Allowances can be made for variations of verbs (e.g., “likes” for “liked,” “join” for “joining”) and minor omissions (e.g., “neighbor” for “neighbor’s”) or changes in number (e.g., “games” for “game”). The content words do not need to be recalled by the subject in the same order they were read to receive credit. The words can appear anywhere in the recall.

Maria's	
child	
Ricky	
played	
soccer	
every	
Monday	
three thirty	
he	
liked	
going	
field	
behind	
their	
house	
joining	
game	
one	
day	
he	
kicked	
ball	
so	

hard	
it	
went	
over	
neighbor's	
fence	
three	
large	
dogs	
lived	
dogs'	
owner	
heard	
loud	
barking	
came	
out	
helped	
them	
retrieve	
ball	
Total	

SCORING

Number of items recalled for verbatim scoring: Immediate Recall Score: _____/44 maximum

Insert the score in the **MarkVCID e-Case Report Form NP Testing Battery #1b Craft Story 21 recall (immediate)**

GUIDELINES FOR PARAPHRASE SCORING, Craft Story 21

Item	General rule	Alternative 1-point responses	0-point responses	Points
Maria's	"Maria" or a variant of the name	Mary, Marie	Martha, Anna	
child	"child" or a phrase denoting it was a young person	son, kid, boy, teenager, young man	guy, children, daughter	
Ricky	"Ricky" or a variant of the name	Rick, Rich, Richie, Richard, Ricardo	Randy, Rusty, Robert	
played	"played" is required	to play, plays	did (soccer)	
soccer	"soccer" is required	futbol	baseball, volleyball, other sport	
every Monday	"Monday" or an indication that it occurred on a weekday	—	every day, another day of the week	
at 3:30	an indication that the activity took place in the afternoon	after school, every afternoon	after dinner, at night, in the morning	
He liked going to the field	an indication that he went to an outdoor area	went outside, went to the yard, going to the backyard	went to the school, gym	
behind their house	"house" or word denoting a house	home, residence, where they lived	any other building	
and joining	an indication that he participated in a game	played w/ other kids, became part of the team, playing w/ the team	watching, played in the park	
the game.	"game" in any context	—	—	
One day	"One day" is required	—	—	
he kicked	indication that he performed the activity with his foot	booted, punted	threw, hit (with no mention of the foot)	
the ball	"Ball" is required	football, soccer ball	baseball, volleyball	
so hard	an indication that force was used	so much force, so strongly, (kicked it) so far	—	
that it went over	"Over" is required	—	—	
the neighbor's	an indication that the person lived in the same area	nearby resident	friend's	
fence	"fence" or a word denoting a fence of some kind	garden wall, wall	property line, street	
where three	"Three" is required	three (boys)	—	
large dogs lived.	an indication that there were dogs present	hounds, doggies	puppies, cats, kittens, other animals	
the dogs' owner	an indication that the person was responsible for the dogs	neighbor (if owner implied and "neighbor" mentioned twice)	a bystander, the police	
heard loud barking	an indication that the dogs were making noise	yelping, baying, yapping, heard the dogs	saw the dogs running around	
came out	a word or phrase indicating that the owner was present	(owner) saw the ball	his mother came out, the dogs came out	
and helped them	a word or phrase indicating that help was provided	assisted, aided, had to help	—	
retrieve the ball.	an indication that they got the ball back	gave him the ball, return the ball, (helped him) get the ball —		

Number of items recalled for **paraphrase scoring**: Immediate Recall Score: _____ /25 maximum

Insert the score in the **MarkVCID e-Case Report Form NP Testing Battery #1c Craft Story 21 recall (immediate)**

Number Span Test (Forward & Backward) Instructions & Worksheets

Corresponds with NACC Form C2 Neuropsychological Battery Scores (UDS 3)

Subject ID _____ Date ____/____/____ Examiner's initials _____

Number Span Test: Forward

SAY: "I am going to ask you to repeat some numbers for me. Wait until I finish saying the numbers and then repeat them in the same order. For example, if I say 1 – 8 – 7, you would say 1– 8 – 7. If I say 2 – 9 – 8, what would you say?" If the subject gives the wrong answer, say, "Actually, you would say 2 – 9 – 8."

SAY: "Repeat only the numbers I say each time." Then start with the test items. Read each item at a pace of 1 number per second.

Before each item, say, "Ready?"

Stop testing after two consecutive failures of the same span length.

Span length	Response	Response code incorrect = 0 correct = 1
3	1- 8 - 4	_____
	2 -7- 9	_____
4	4 -1- 6 - 2	_____
	8 - 1- 9 - 5	_____
5	6 - 4 - 9 - 2 - 8	_____
	7 - 3 - 8 - 6 - 1	_____
6	3 - 9 - 2 - 4 - 7 - 5	_____
	6 - 2 - 8 - 3 - 1 - 9	_____
7	9 - 6 - 4 - 7 - 1 - 5 - 3	_____
	7 - 4 - 9 - 2 - 6 - 8 - 1	_____
8	4 - 7 - 2 - 5 - 8 - 1 - 3 - 9	_____
	2 - 9 - 5 - 7 - 3 - 6 - 1 - 8	_____
9	6-8-4-1-9-3-5-2-7	_____
	1-3-9-2-7-5-8-6-4	_____
Total correct:		_____
Length of longest correct series:		_____

Reproduced by permission of the author, Joel Kramer, PsyD; do not copy or distribute without author's permission. Form created as part of the Uniform Data Set of the National Alzheimer's Coordinating Center, copyright ©2013 University of Washington.

Insert the score in the **MarkVCID e-Case Report Form NP Testing Battery #3 Number Span test – Forward.**

Number Span Test: Backward

SAY: "I am now going to ask you to repeat some numbers for me but to reverse them from the way I say them. Wait until I finish saying the numbers and then repeat them in reverse order, or backward. For example, if I say 3-7-4, you would say 4-7-3. If I say 7-3-6, what would you say?" If the subject gives the wrong answer, say, "Actually, you would say 6-3-7."

SAY: "Repeat only the numbers I say each time, backward, in reverse order." Then start with the test items. Read each item at a pace of 1 number per second. Before each item, say, "Ready?"

Stop testing after two consecutive failures of the same span length

Span length		Response	Response code incorrect = 0 correct = 1
2	2 - 5		_____
	4 - 7		_____
3	2 - 9 - 6		_____
	3 - 7 - 4		_____
4	7 - 1 - 8 - 6		_____
	5 - 1 - 6 - 3		_____
5	5 - 2 - 4 - 9 - 1		_____
	9 - 1 - 7 - 3 - 6		_____
6	6 - 8 - 5 - 7 - 9 - 2		_____
	8 - 1 - 6 - 3 - 5 - 9		_____
7	1 - 5 - 2 - 9 - 7 - 3 - 8		_____
	7 - 3 - 1 - 6 - 8 - 5 - 2		_____
8	3 - 6 - 4 - 9 - 5 - 2 - 7 - 1		_____
	6 - 3 - 5 - 7 - 1 - 8 - 2 - 9		_____
Total correct:			_____
Length of longest correct series:			_____

Reproduced by permission of the author, Joel Kramer, PsyD; do not copy or distribute without author's permission. Form created as part of the Uniform Data Set of the National Alzheimer's Coordinating Center, copyright ©2013 University of Washington.

Insert the score in the **MarkVCID e-Case Report Form NP Testing Battery #4 Number Span test – Backward.**

Category Fluency Worksheets

Corresponds with NACC Form C2 Neuropsychological Battery Scores (UDS 3)

Subject ID _____

Date ____/____/____

Examiner's initials _____

Category Fluency

INSTRUCTIONS SAY: "I am going to give you a category and I want you to name, as fast as you can, all of the things that belong in that category. For example, if I say 'articles of clothing,' you could say 'shirt,' 'tie,' or 'hat.' Can you think of other articles of clothing?"

Allow up to 20 seconds for the subject to produce two responses. Circle the number corresponding to the subject's responses, and read the associated instruction.

Response code		Instruction
0	(No response)	"You could have said 'shoes' or 'coat' since they are articles of clothing."
1	(One or more incorrect responses, no correct response)	"No, ___ is (are) not an article(s) of clothing. You could have said 'shoes' or 'coat' since they are articles of clothing."
2	(One or more correct response, no incorrect responses)	"That's right. You also could have said 'shoes' or 'coat'."
3	(One or more correct responses, one or more incorrect responses)	"_____ is (are) correct, but _____ is (are) not an article of clothing. You also could have said 'shoes' or 'coat'."
4	(Two or more correct responses)	"That's right."

Next, read the instructions for the Animals category (worksheet follows this instruction page):

SAY: "Now I want you to name things that belong to another category: Animals. You will have one minute. I want you to tell me all the animals you can think of in one minute. Ready? Begin."

Start timer as you say "Begin." Write actual responses as legibly as possible on the Worksheet for Category Fluency — Animals. Stop the procedure at 60 seconds. One prompt ("tell me all the animals you can think of") is permitted if the participant makes no response for 15 seconds or expresses incapacity (e.g., "I can't think of any more"). It is also permissible to repeat the instruction or category if the subject specifically requests it.

Insert the score in the **MarkVCID e-Case Report Form NP Testing Battery #5 Category Fluency – Animals.**

Worksheet for Category Fluency — Animals

- | | | |
|-----------|-----------|-----------|
| 1. _____ | 27. _____ | 53. _____ |
| 2. _____ | 28. _____ | 54. _____ |
| 3. _____ | 29. _____ | 55. _____ |
| 4. _____ | 30. _____ | 56. _____ |
| 5. _____ | 31. _____ | 57. _____ |
| 6. _____ | 32. _____ | 58. _____ |
| 7. _____ | 33. _____ | 59. _____ |
| 8. _____ | 34. _____ | 60. _____ |
| 9. _____ | 35. _____ | 61. _____ |
| 10. _____ | 36. _____ | 62. _____ |
| 11. _____ | 37. _____ | 63. _____ |
| 12. _____ | 38. _____ | 64. _____ |
| 13. _____ | 39. _____ | 65. _____ |
| 14. _____ | 40. _____ | 66. _____ |
| 15. _____ | 41. _____ | 67. _____ |
| 16. _____ | 42. _____ | 68. _____ |
| 17. _____ | 43. _____ | 69. _____ |
| 18. _____ | 44. _____ | 70. _____ |
| 19. _____ | 45. _____ | 71. _____ |
| 20. _____ | 46. _____ | 72. _____ |
| 21. _____ | 47. _____ | 73. _____ |
| 22. _____ | 48. _____ | 74. _____ |
| 23. _____ | 49. _____ | 75. _____ |
| 24. _____ | 50. _____ | 76. _____ |
| 25. _____ | 51. _____ | 77. _____ |
| 26. _____ | 52. _____ | |

Trail Making A & B Worksheets

Corresponds with NACC Form C2 Neuropsychological Battery Scores (UDS 3)

Subject ID _____

Date ____/____/____

Examiner's initials _____

Trail Making Test

Part A

Place the form for SAMPLE A in front of the subject. Read aloud the instructions:

SAY: "There are numbers in circles on this page. Please take the pencil and draw a line from one number to the next, in order. Start at 1 [point to the number], then go to 2 [point to the number], then go to 3 [point to the number] and so on. Please try not to lift the pencil as you move from one number to the next. Work as quickly as you can. Begin here [point to "Begin" number] and end here [point to "End" number]."

If the subject makes an error, mark through the line and go back to the point at which the error was made and say, for example, **"You were at number 2. What is the next number?"** Wait for the subject's response. If the subject indicates 3, say **"Please start here [point to the 2] and continue."** If the subject indicates any other number, say **"the next number would be 3."** Then point to 2 and say **"Please start here and continue."** If the subject cannot complete the sample and clearly does not comprehend the task, do not administer Test.

A. In that event, on the recording form enter the appropriate code (996 = cognitive/ behavioral problem).

If the subject completes the sample, go to TEST A.

SAY: "On this page there are more numbers in circles. Please take the pencil and draw a line from one circle to the next, in order. Start at 1 [point to "Begin" number] and end here [point to "End" number]. Please try not to lift the pencil as you move from one circle to the next. Work as quickly as you can." Start timing as soon as the instruction is given to begin.

NOTE: In giving the instructions for the test form (as opposed to the sample), the examiner tells the subject to move from one circle to the next and does not use the word "number."

If the subject makes an error, mark through the line and say **"that one was not correct."** Point to the last correct number and say **"Please start here and continue."** This is done for each error. The examiner should attempt to provide corrections as quickly as possible. Stop timing when the Trail is completed, or stop subject when the maximum time is reached. Allow a maximum of 150 seconds for the test.

Part B

Place the form for SAMPLE B in front of the subject. Present the sample for Part B even if the subject failed the sample for Part A. Read aloud the instructions:

SAY: "there are numbers and letters in circles on this page. Please take the pencil and draw a line, alternating in order between the numbers and letters."

Start at number 1 [point to the number], **then go to the first letter, A** [point to the letter], **then go to the next number, 2** [point to the number], **and then the next letter, B** [point to the letter], **and so on. Please try not to lift the pencil as you move from one number or letter to the next. Work as quickly as you can.**”

If the subject makes an error, mark through the line and go back to the point at which the error was made and say, for example, **“You were at number 2. What is the next letter?”** Wait for the subject’s response. If it is correct, say **“Please start here** [point to the 2] **and continue.”** If the subject picks the wrong item, say **“the next letter would be B** [point to the B].” Then point to the 2 and say **“Please start here and continue.”** If the subject cannot complete the sample and clearly does not comprehend the task, do not administer the test. Enter the appropriate code (996 = cognitive/behavioral problem).

If the subject completes the sample correctly, go to TEST B.

SAY: **“On this page, there are more numbers and letters in circles. Please take the pencil and draw a line from one circle to the next, alternating in order between the numbers and letters. Start at 1** [point to the “Begin” number] **and end here** [point to the “End” number]. **Please try not to lift the pencil as you move from one circle to the next. Work as quickly as you can.”** Start timing as soon as the instruction is given to begin.

NOTE: In giving the instructions for the test form (as opposed to the sample), the examiner tells the subject to move from one circle to the next and does not use the words “number” or “letter.”

If the subject makes an error, mark through the line and say, **“that one was not correct.”** Point to the last correct item and say, **“Please start here and continue.”** This is done for each error. Do not indicate whether the next item should be a number or a letter. The examiner should attempt to provide corrections as quickly as possible. Stop timing when the Trail is completed, or stop subject when the maximum time is reached. Allow a maximum of 300 seconds for the test.

Insert the score in the **MarkVCID e-Case Report Form NP Testing Battery Trail Making Test A (#7) and B (#8).**

Sample A

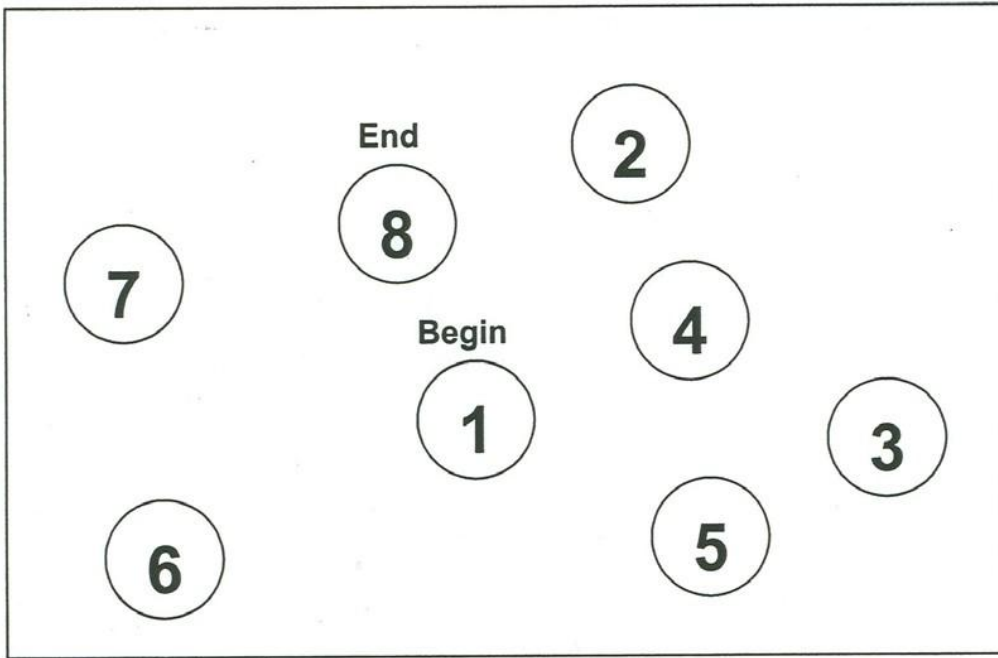

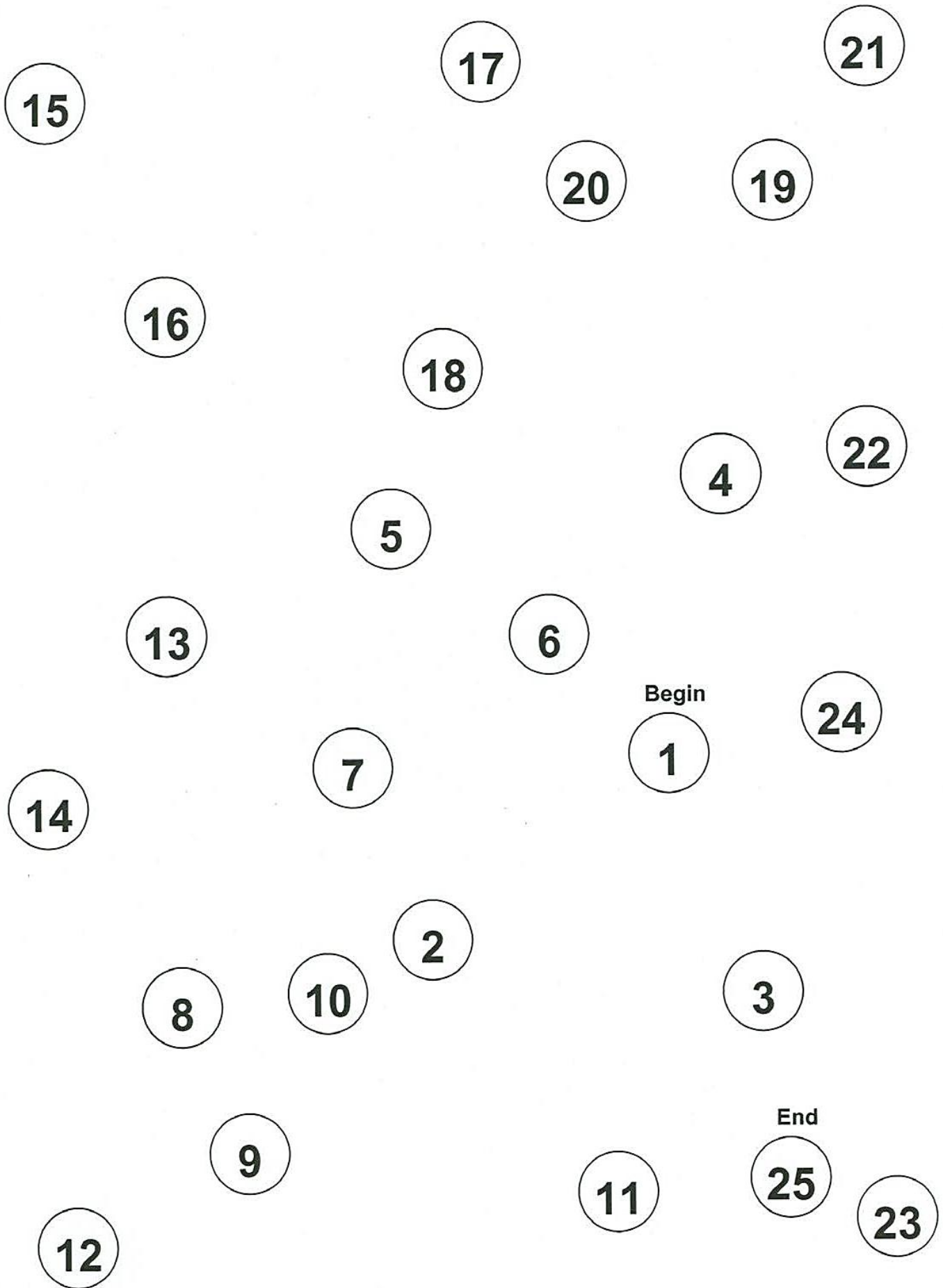

Sample B

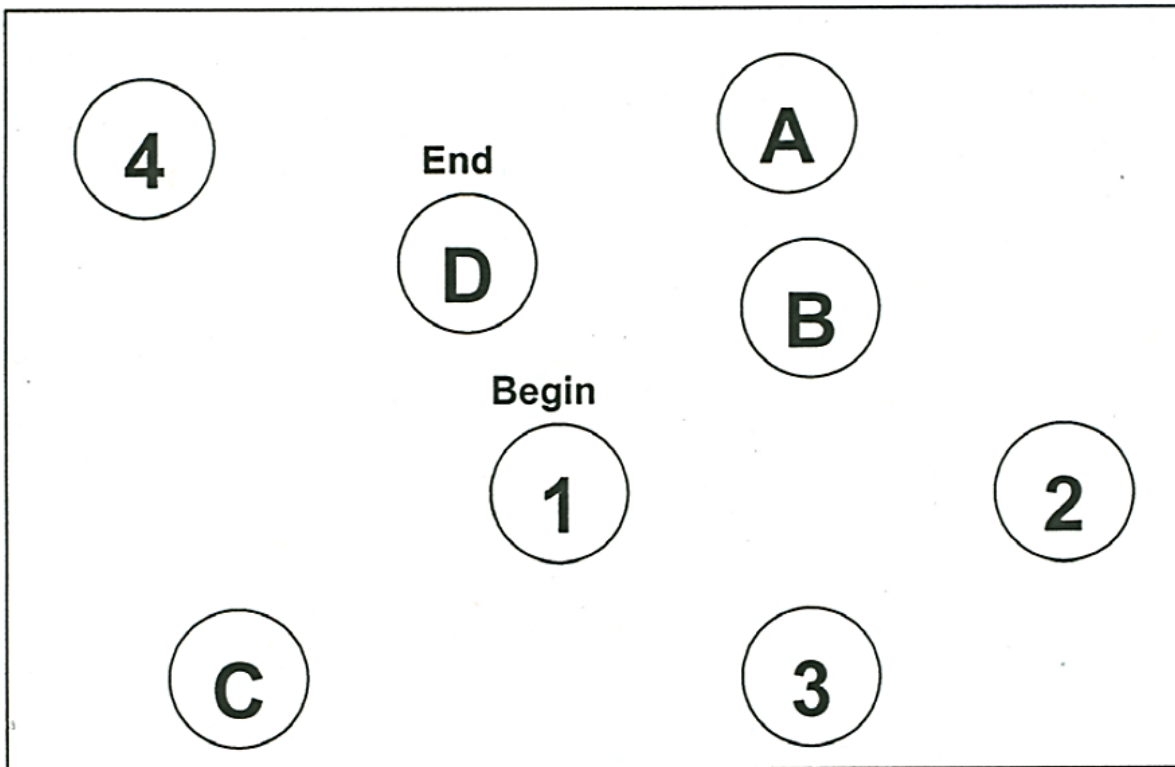

End

13

10

9

I

D

8

4

B

3

Begin

7

1

5

H

C

12

G

A

J

2

6

L

E

F

11

K

Multilingual Naming Test (MINT) Worksheets

Corresponds with NACC Form C2 Neuropsychological Battery Scores (UDS 3)

Subject ID _____

Date ____/____/____

Examiner's initials _____

MINT (Multilingual Naming Test)

Instructions and Cueing

SAY: "I am going to show you some pictures of objects, one at a time. Please tell me the name of each object, that is, tell me what it is called. If you cannot think of the name try to make your best guess. If you don't know what the object is, I will try to help you. Do you have any questions?"

Stop testing after six consecutive failures.

Item #	English	Semantic cue	Spontaneous response(s)	Uncued	Semantic cue		Phonemic cue	
				correct	correct	incorrect	correct	incorrect
1	B utterfly	an insect						
2	G love	an article of clothing						
3	L ightbulb	used to see better and is turned on electrically						
4	W atch	used to tell the time						
5	C andle	is used in the dark to make light						
6	C lown	found in a circus						
7	K ite	a toy that uses the wind to make it fly						
8	r ainbow	it's colorful and is found in the sky after it rains						
9	W itch	a woman with magical powers						
10	S eesaw	found on a playground						
11	F lashlight	used to see better and is battery- operated						
12	P eacock	a bird						
13	S nail	an animal						
14	W hale	an ocean animal						
15	C age	an enclosure for animals						
16	n est	it's where birds lay their eggs						

Item #	English	Semantic cue	Spontaneous Response(s)	Uncued	Semantic cue		Phonemic cue	
				correct	correct	incorrect	correct	incorrect
17	<u>P</u>lug	found on electronic devices						
18	<u>W</u>ig	it's worn on the head						
19	<u>S</u>crew	it's like a nail but it grooves into wood or a wall						
20	<u>S</u>carf	clothing worn on the neck						
21	<u>W</u>ell	used to obtain water						
22	<u>D</u>ustpan	used to remove dust and trash						
23	<u>P</u>a rachute	used to jump from airplane						
24	<u>B</u>lind	used to block out light						
25	<u>H</u>inge	part of a door						
26	<u>F</u>unnel	used for pouring liquid from one container to another						
27	<u>G</u>auge	used to measure air pressure						
28	<u>P</u>orthole	found on a ship						
29	<u>A</u>nvil	used for shaping metal						
30	<u>M</u>ortar	used to grind different substances						
31	<u>P</u>estle	used to grind different substances						
32	<u>A</u>xle	a supporting shaft on which wheels revolve						

SCORING:

1.0 point for each correct answer under Uncued or Semantic columns, 0.0 points for correct answer under Phonemic column

a. Total correct without a cue ("Uncued" column): _____

b. Total correct with a semantic cue given ("Semantic" column): _____

c. Total correct (sum of a+b, maximum of 32): _____

Insert the score in the **MarkVCID e-Case Report Form NP Testing Battery #9 Multilingual Naming Test**

MiNT

Multilingual Naming Test

For speakers of English, Spanish, Mandarin, Hebrew, or any combination of these languages

Address for correspondence: tgollan@ucsd.edu

Ivanova, I., Salmon, D.P., & Gollan, T.H. The Multilingual Naming Test in Alzheimer's disease: Clues to the origin of naming impairments. *The Journal of the International Neuropsychological Society*, 2013; 19:272-283.

Gollan, T.H., Weissberger, G., Runnqvist, E., Montoya, R.I., & Cera, C.M. (2012) Self- ratings of spoken language dominance: A multi-lingual naming test (MINT) and preliminary norms for young and aging Spanish-English bilinguals. *Bilingualism: Language and Cognition*, 15, 594-615.

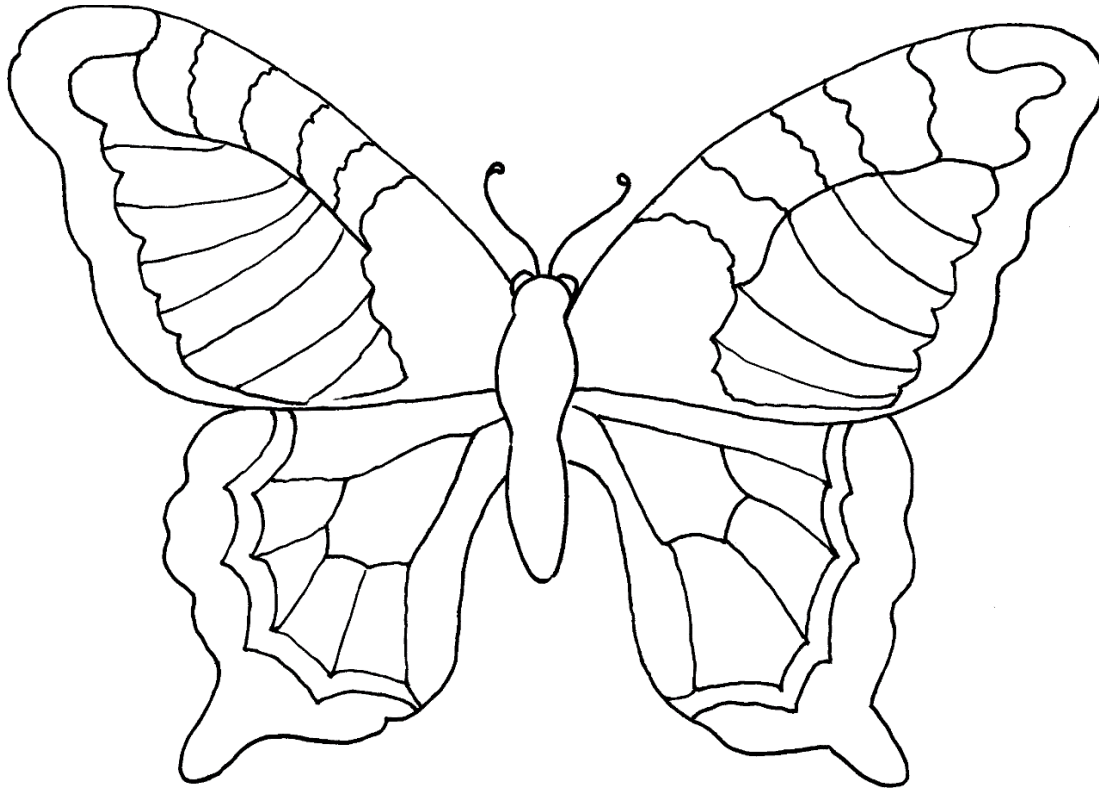

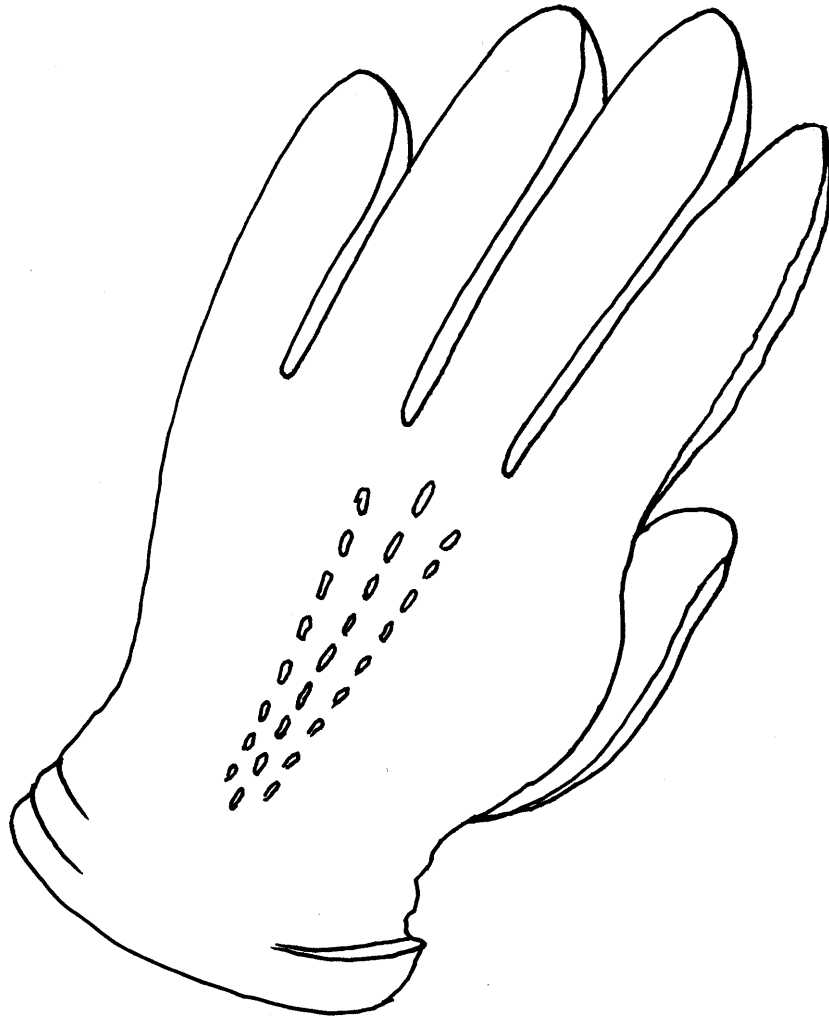

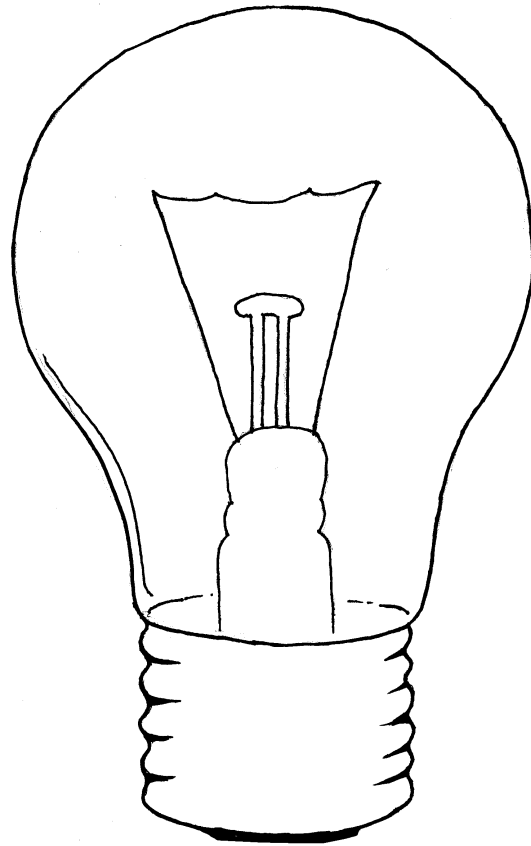

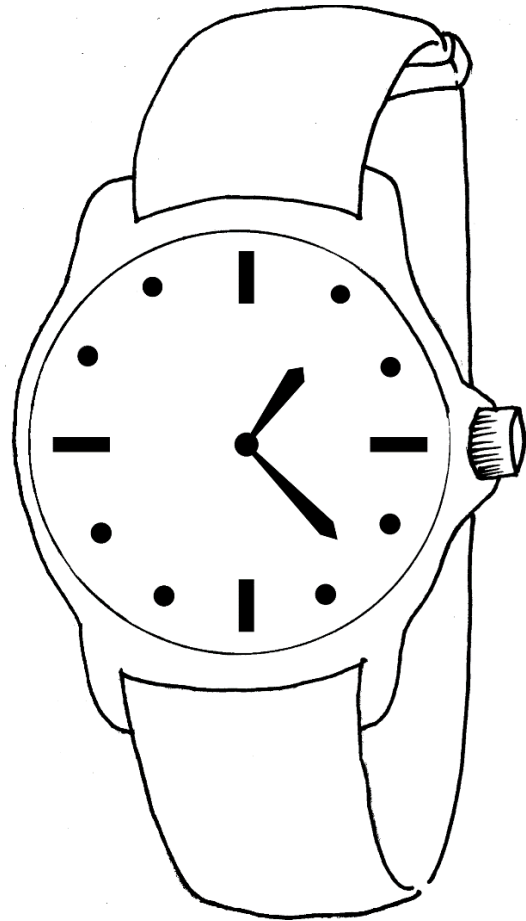

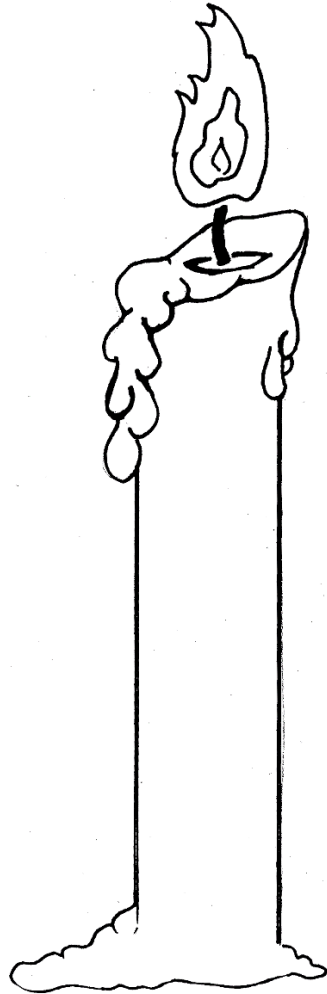



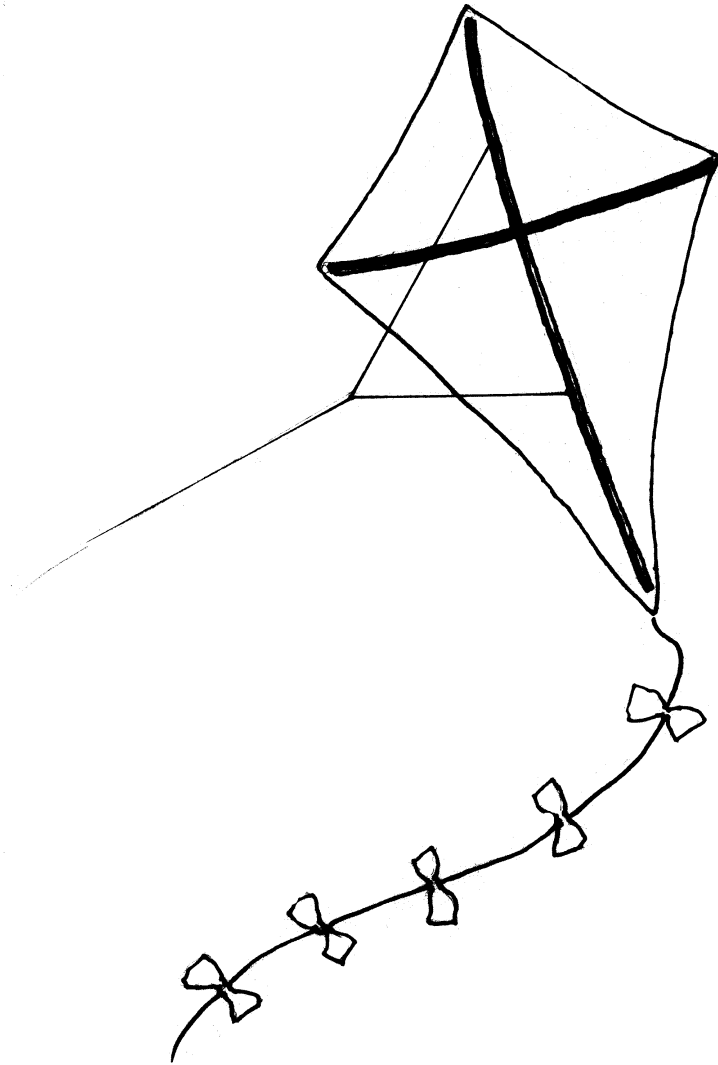

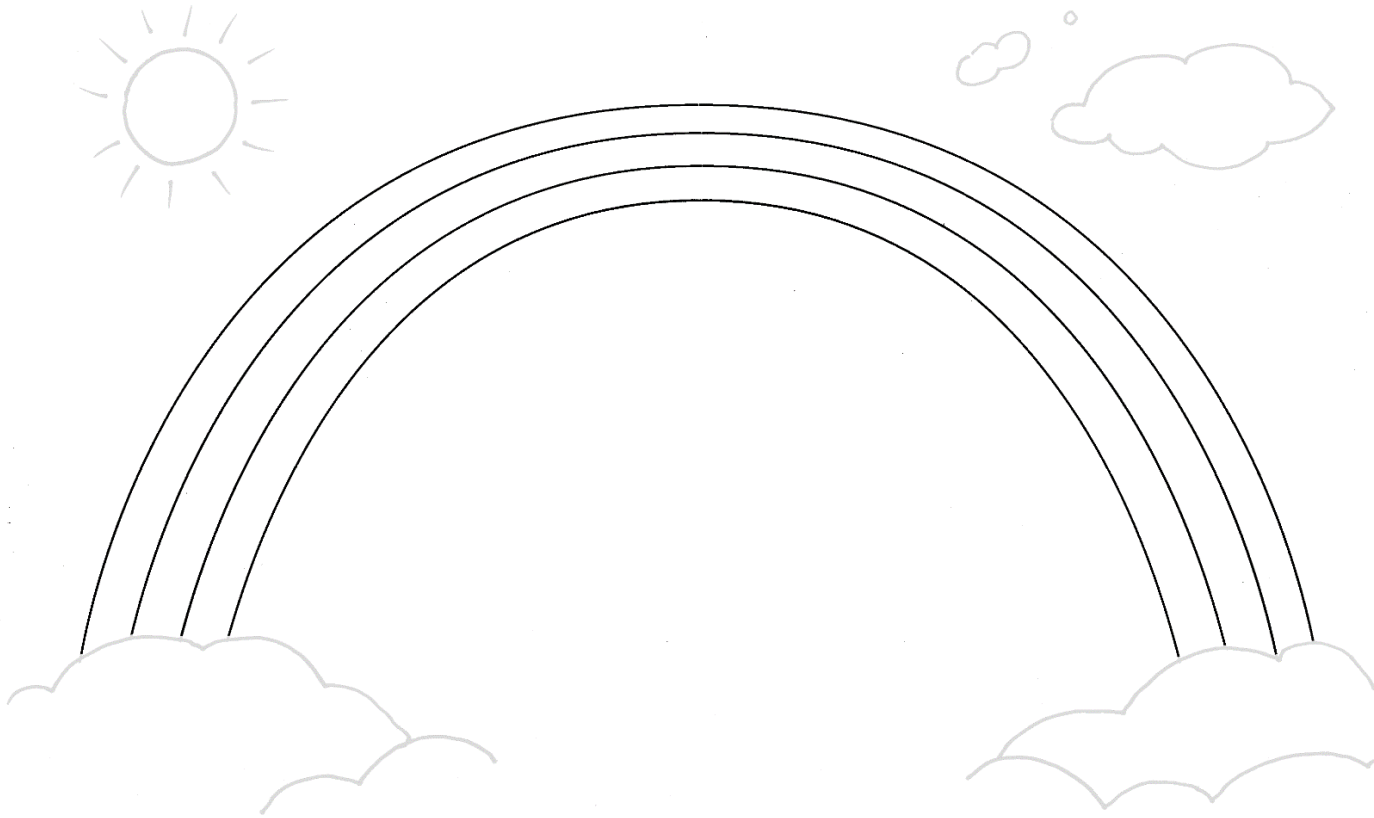



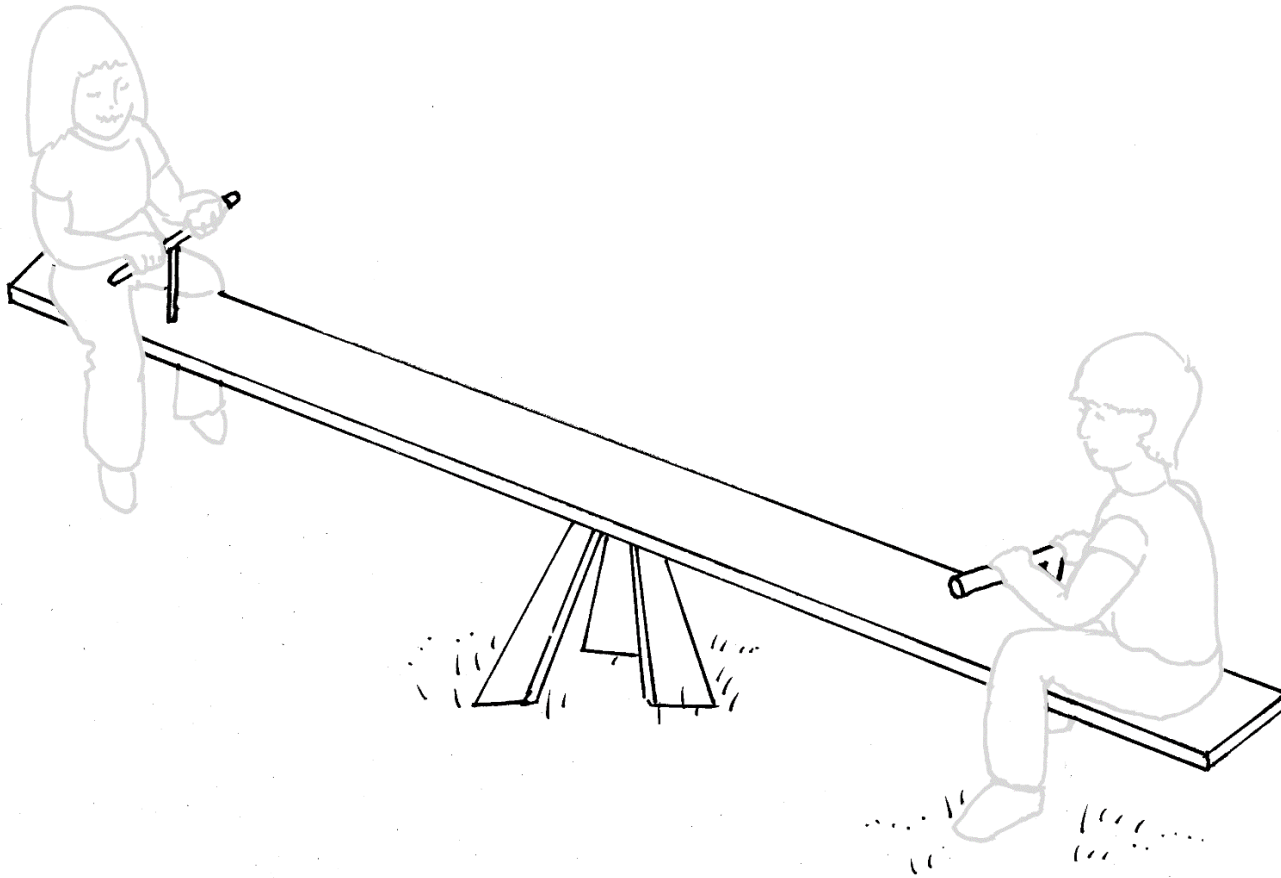

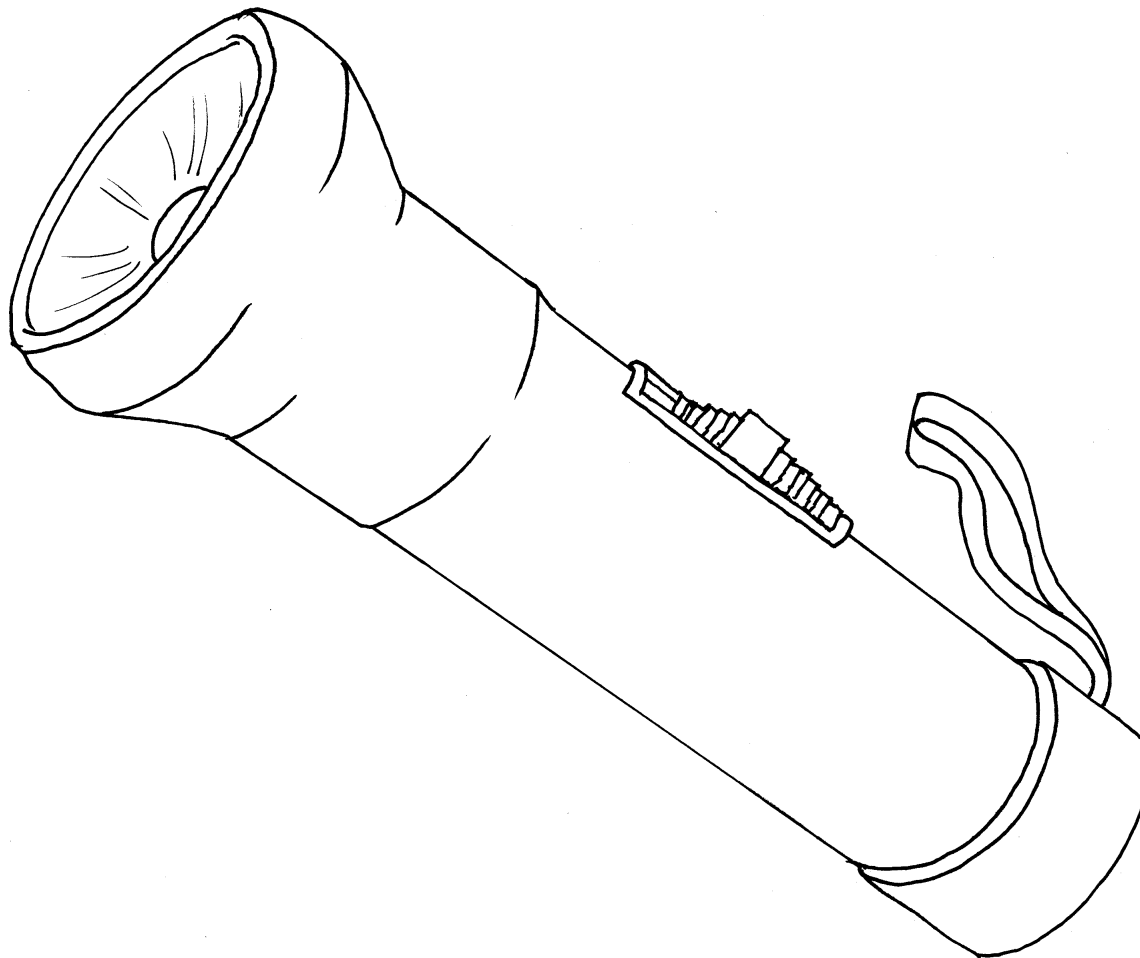

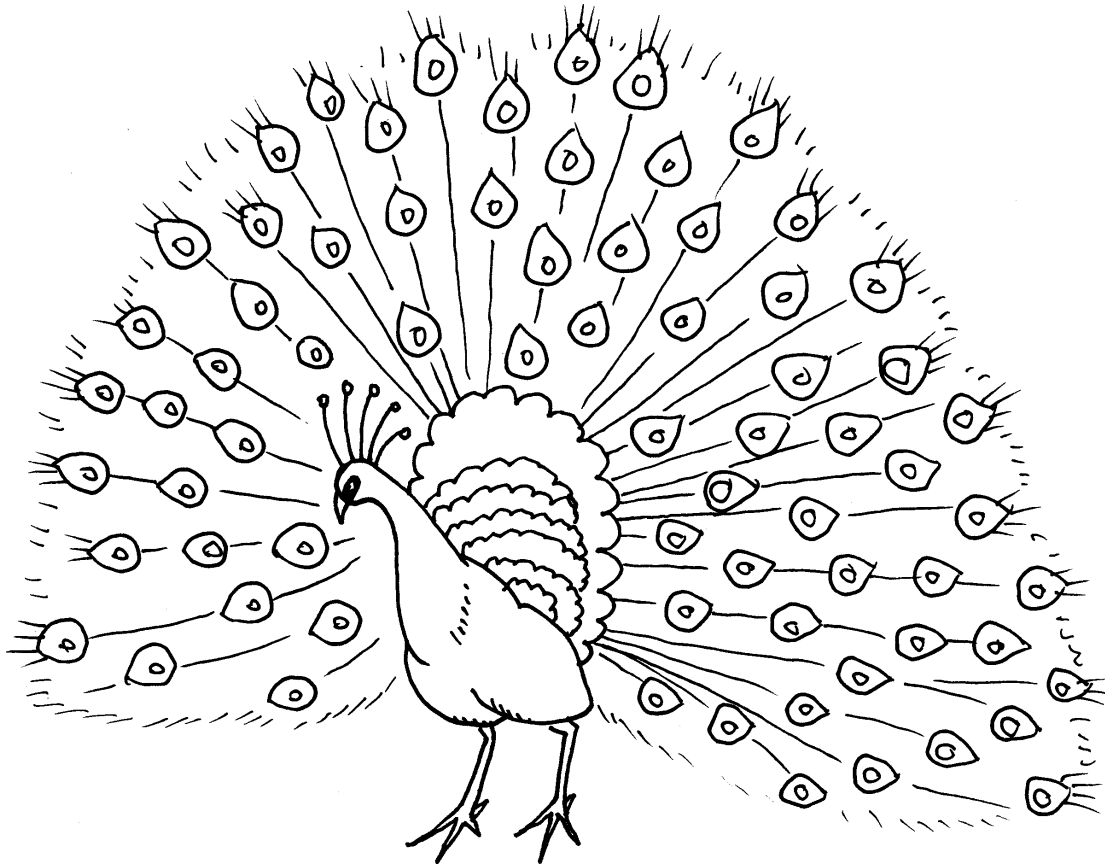

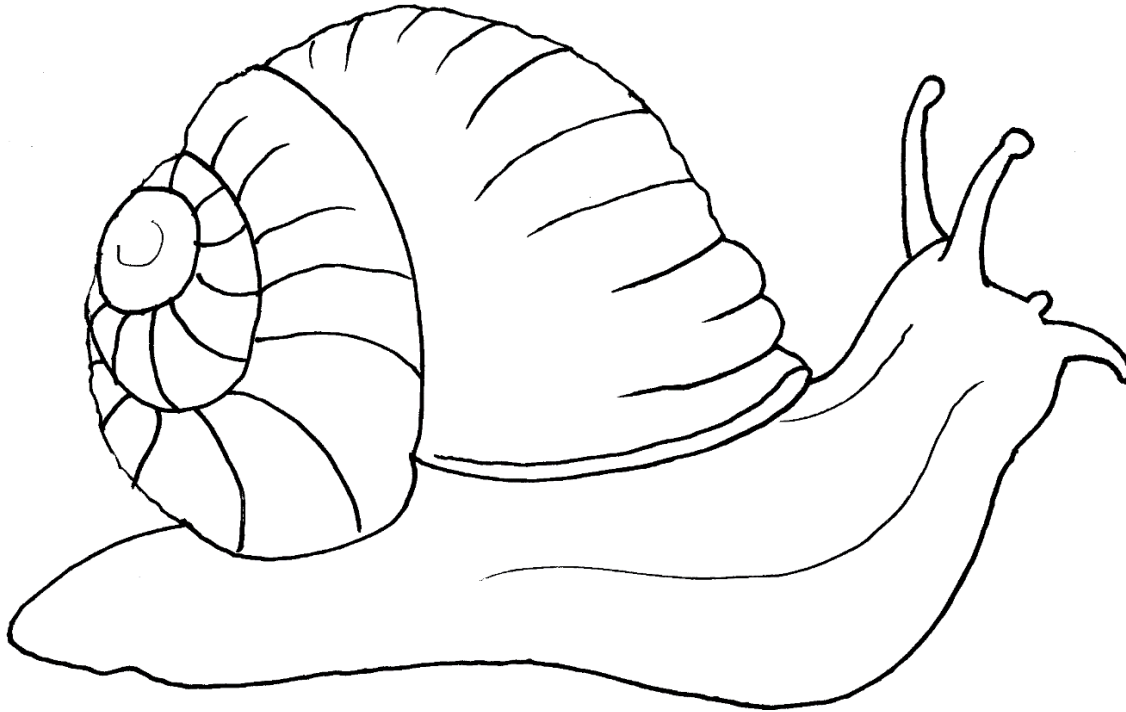

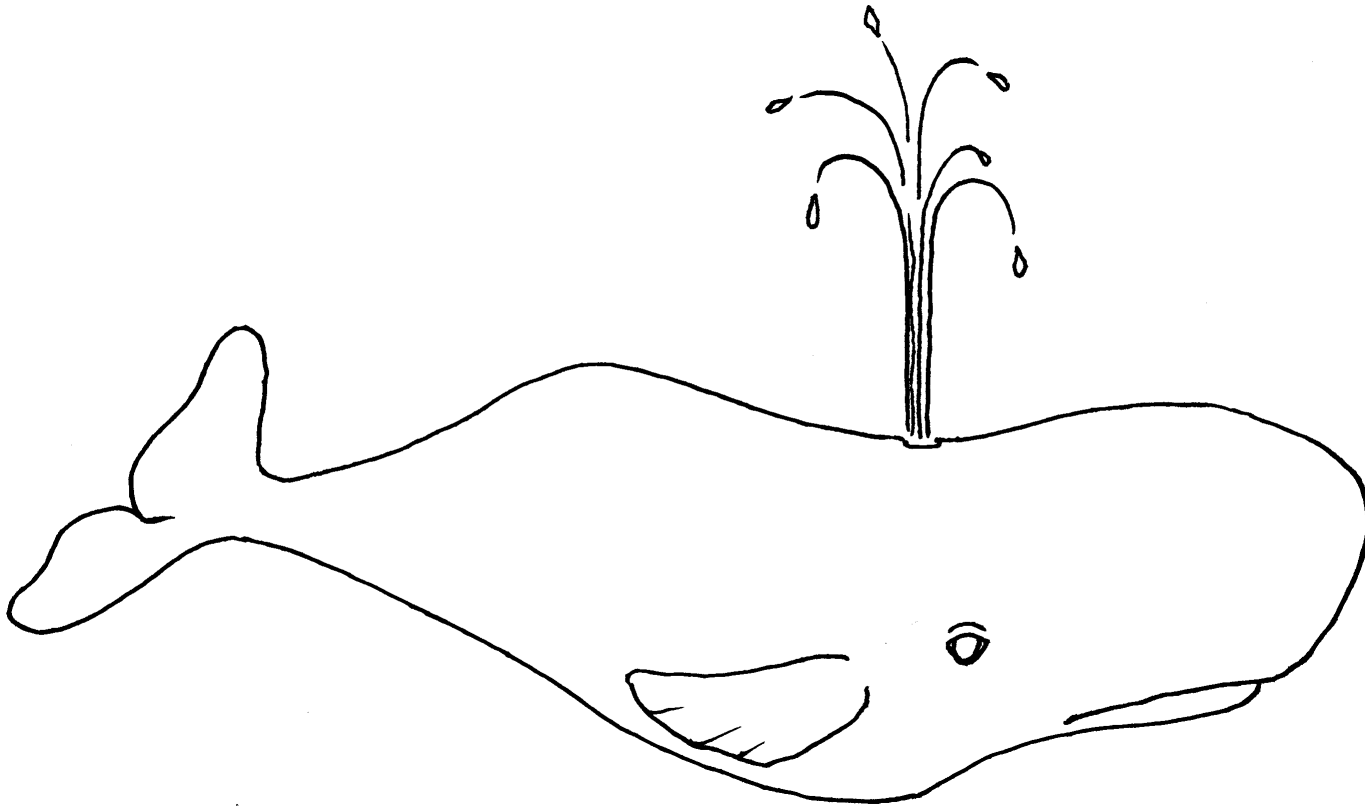

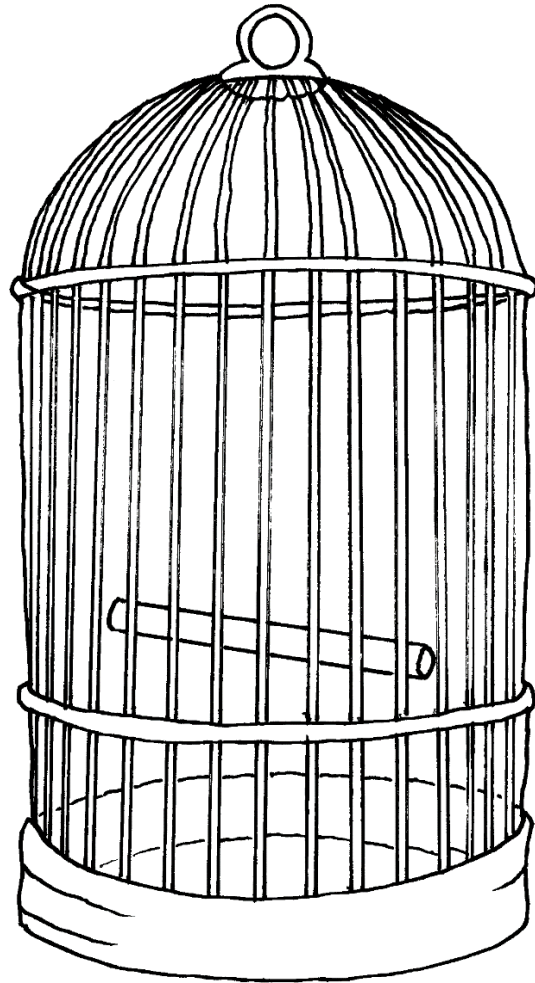



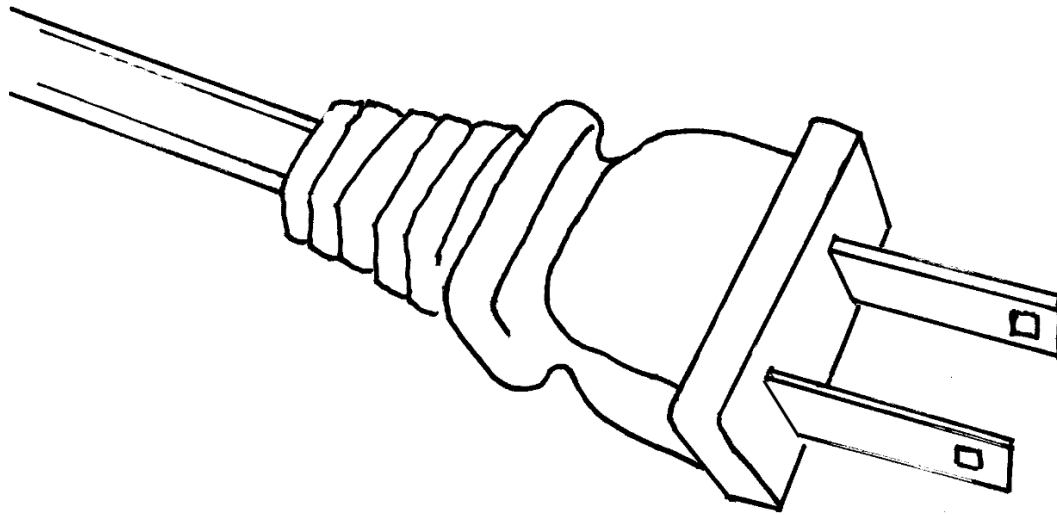

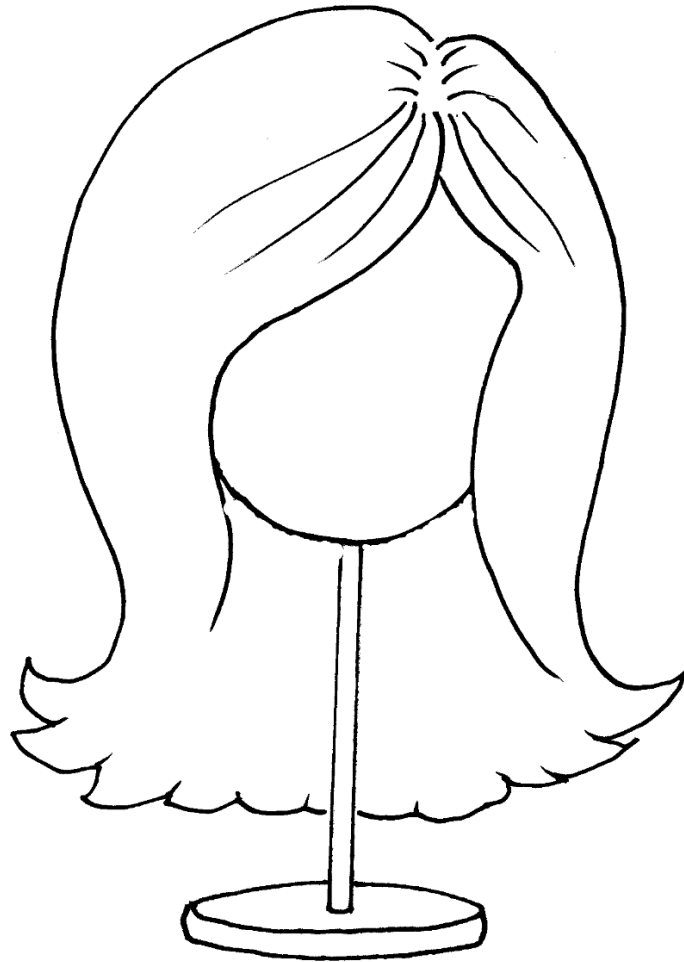

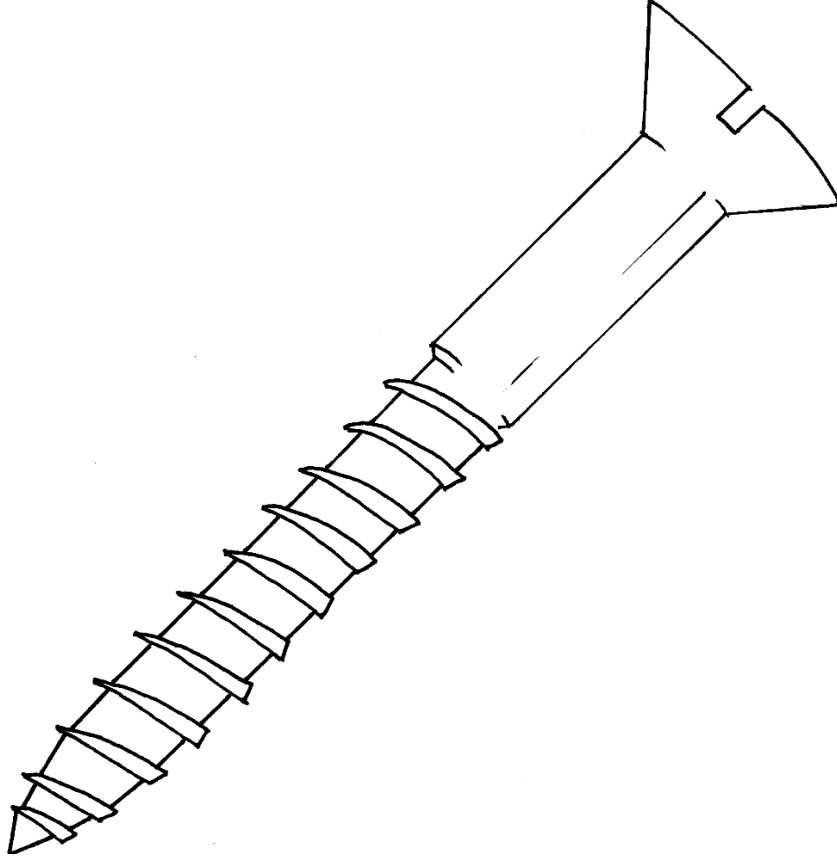

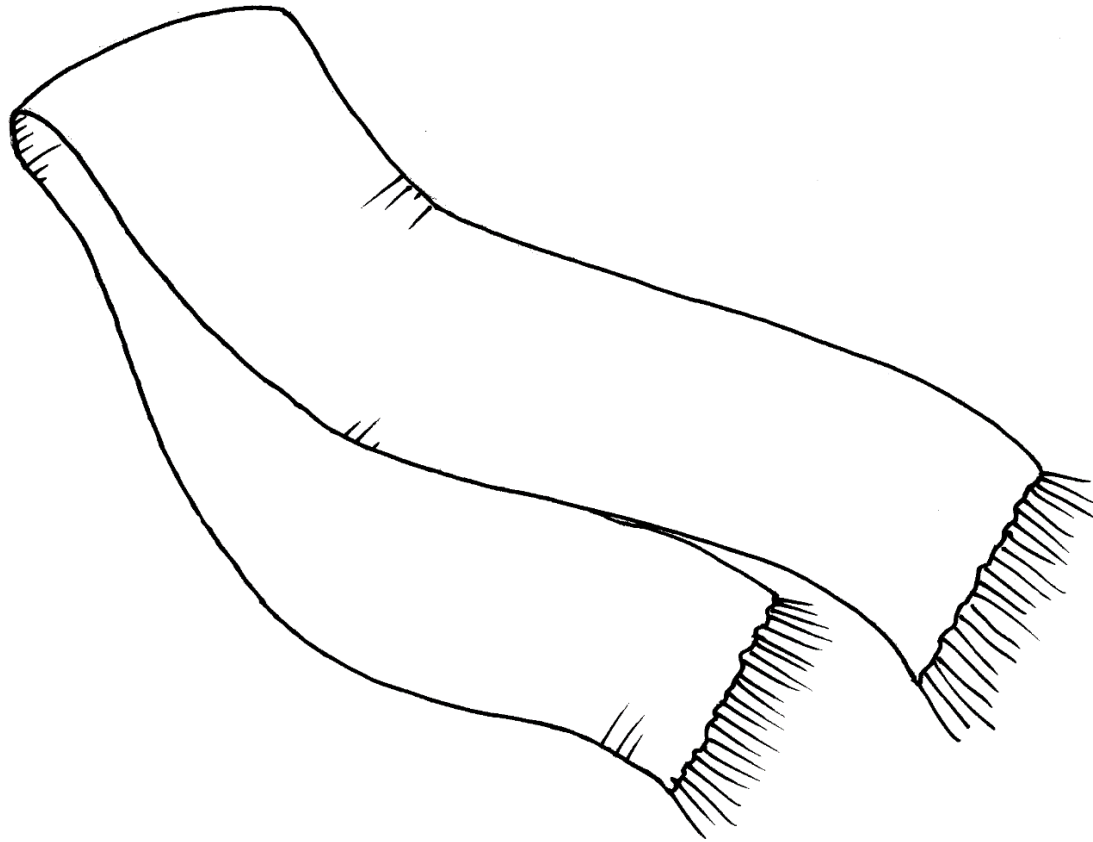

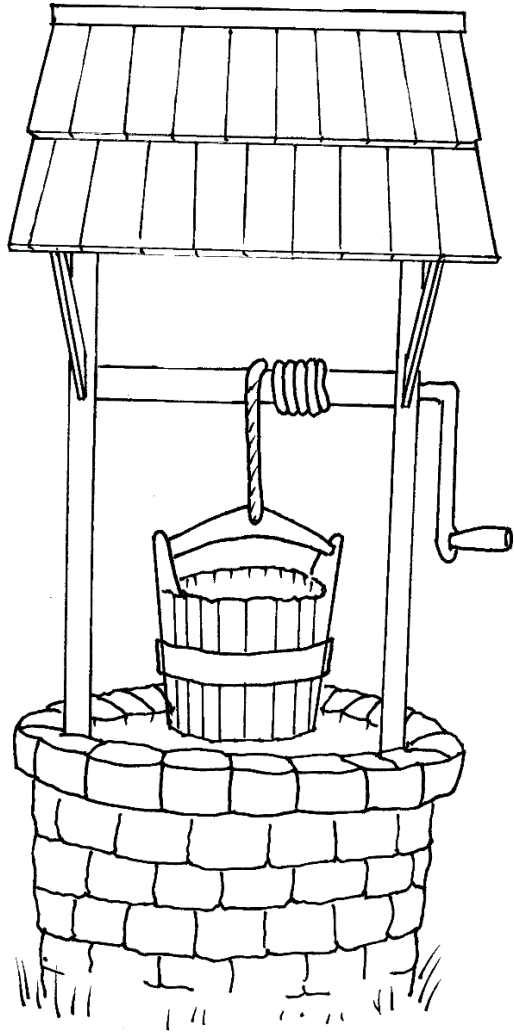

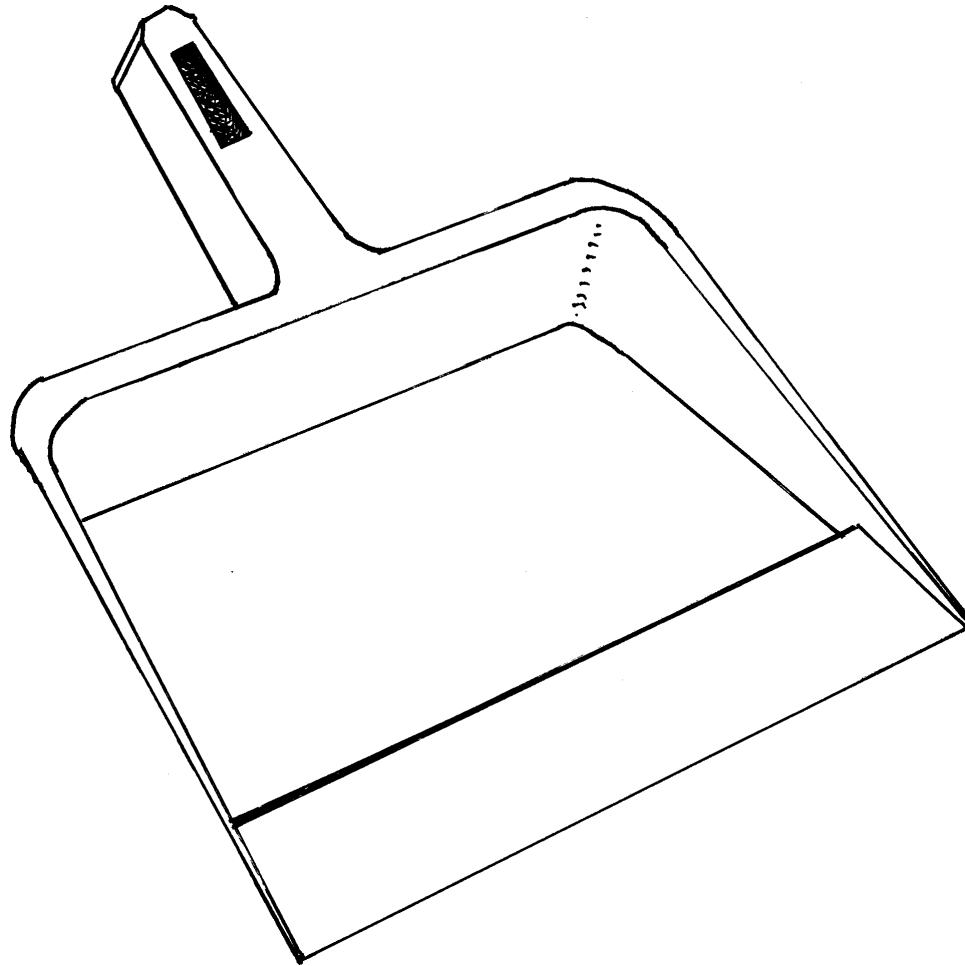

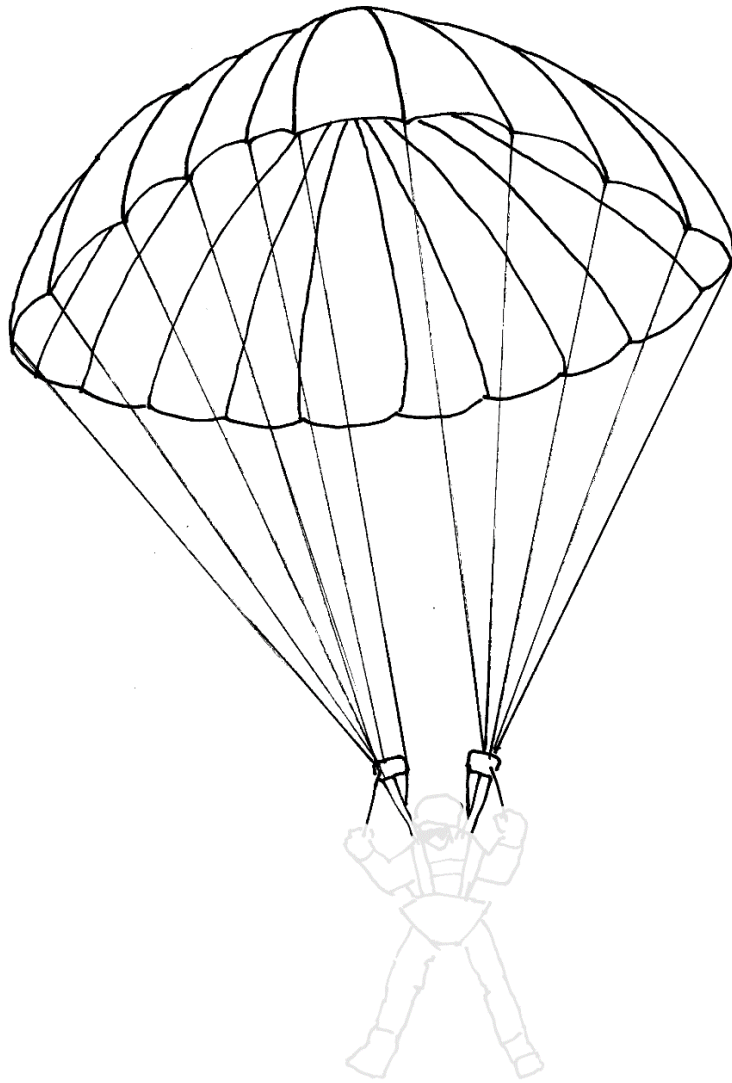

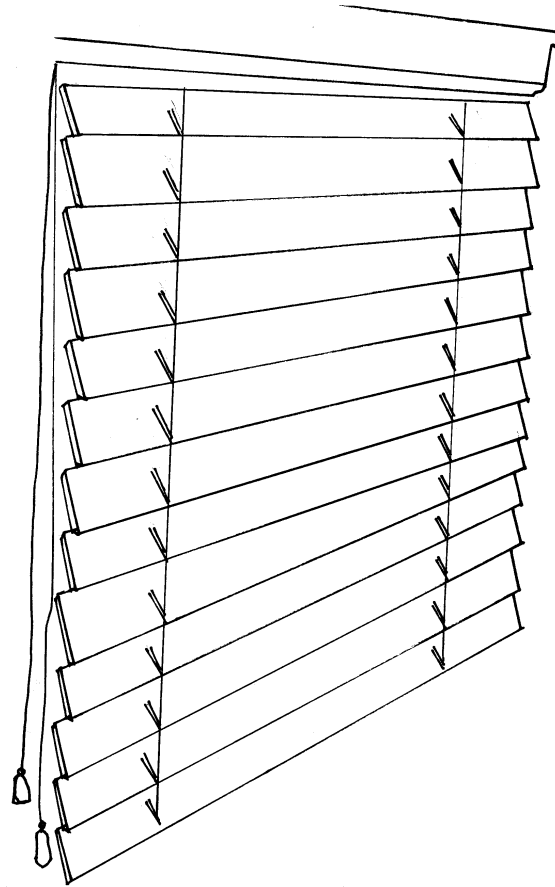

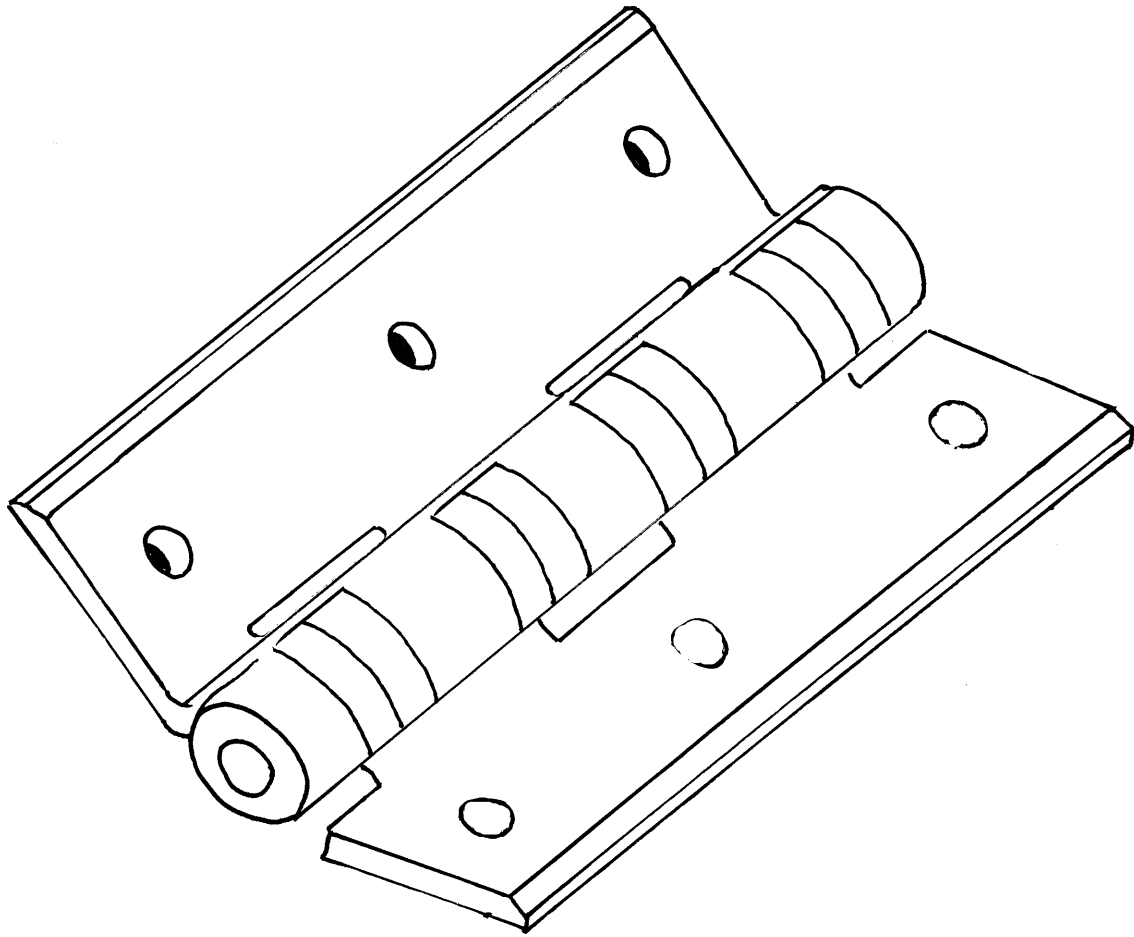

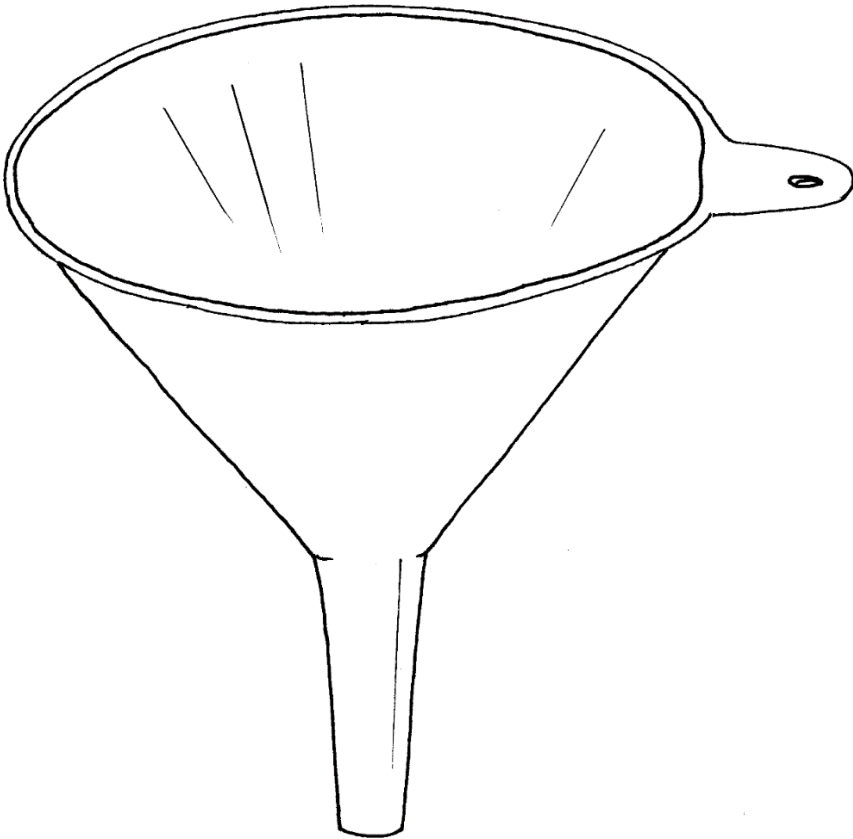

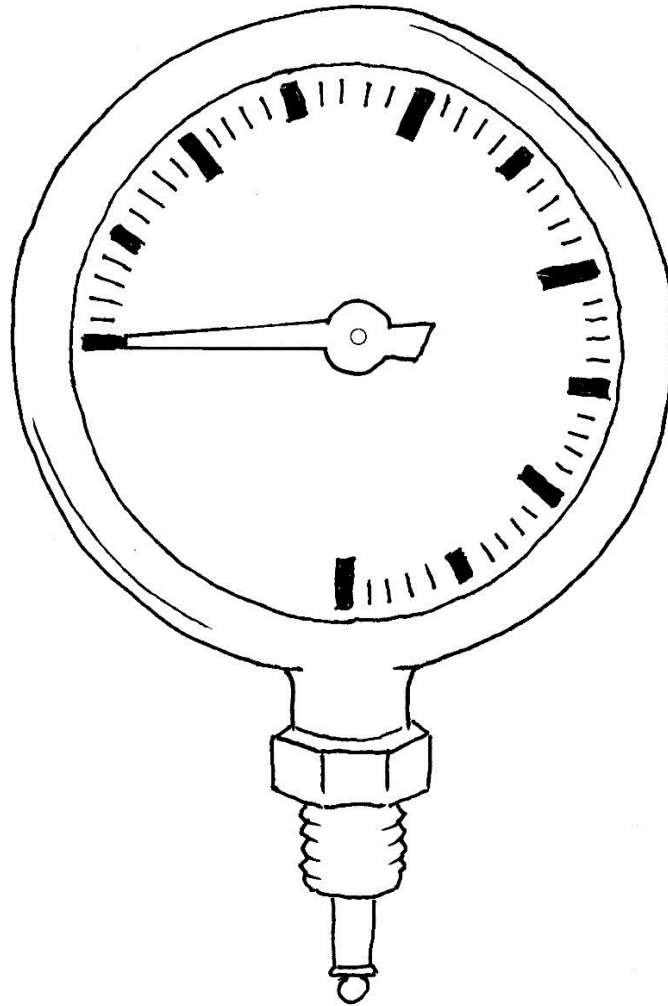

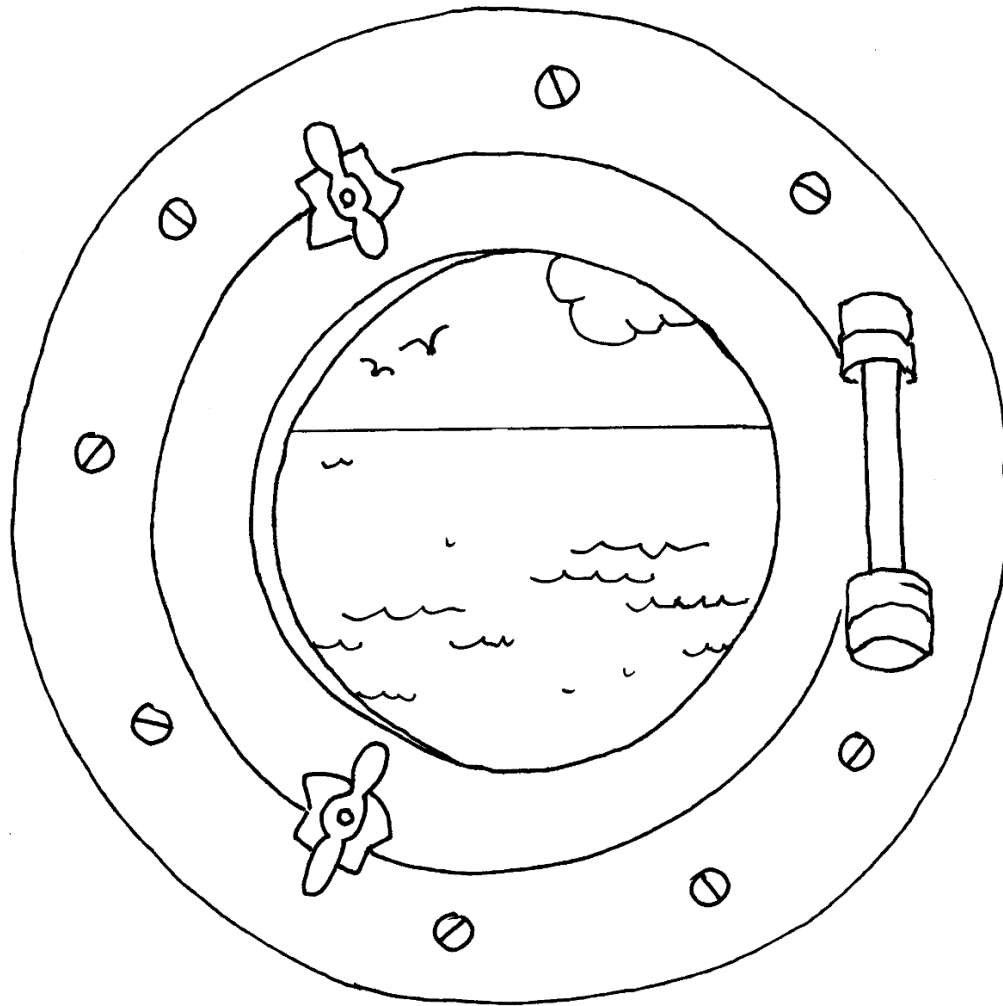

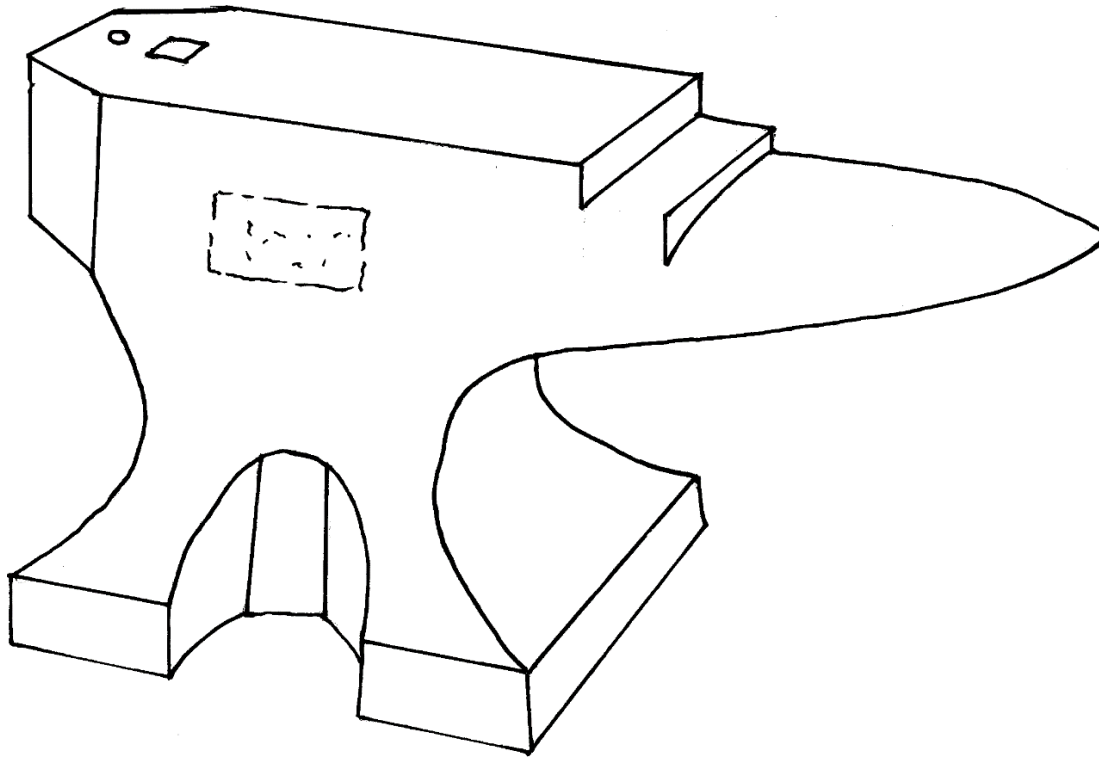

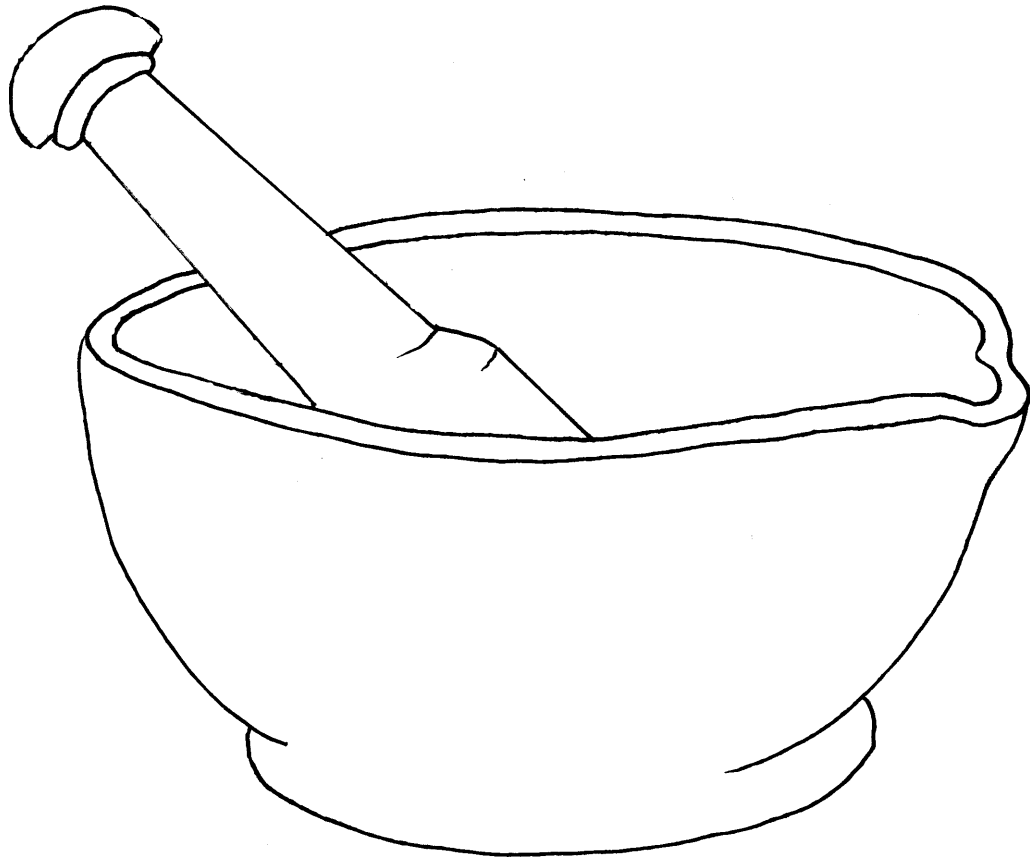

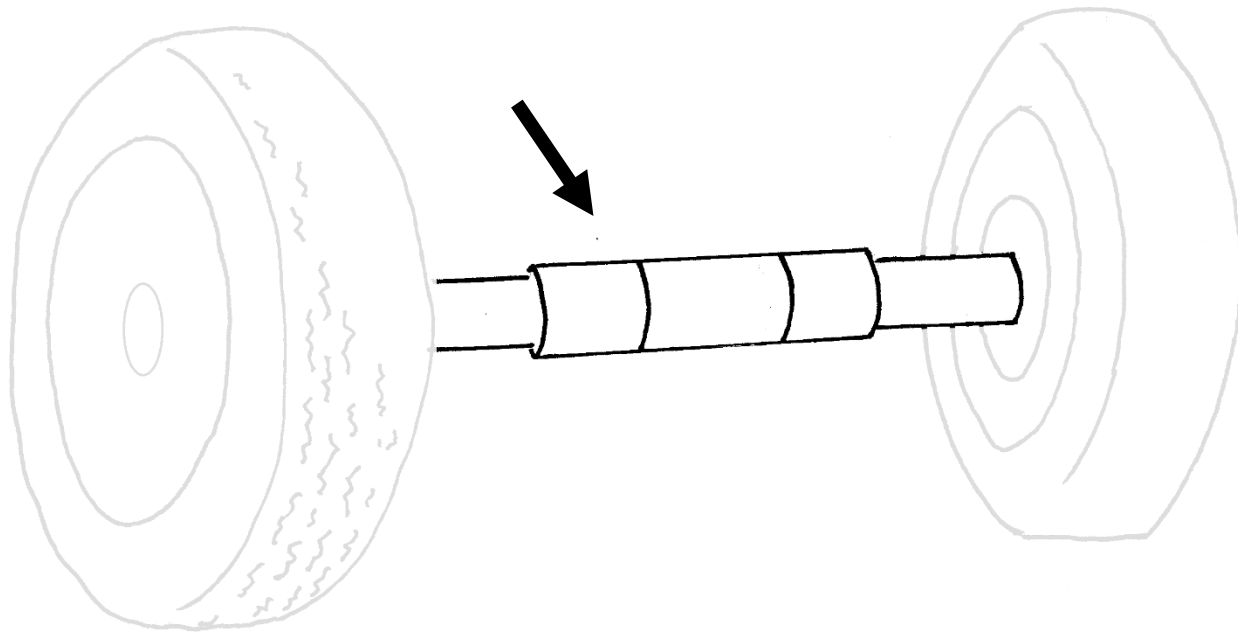

Craft Story 21 Recall (Delayed) Worksheets

Corresponds with NACC Form C2 Neuropsychological Battery Scores (UDS 3)

Subject ID _____

Date ____/____/____

Examiner's initials _____

Craft Story 21 Recall (Delayed)

Instructions: Administer this test approximately 20 minutes after Craft Story 21 Recall (Immediate), making note of the time administration of Craft Story 21 Recall (Delayed) began. NOTE: If 20 minutes have not elapsed, do not add other tests to fill the interval. You may obtain other data, such as blood pressure, weight, etc. Administer Craft Story 21 Recall (Delayed) and record the actual time elapsed.

SAY: "I read you a story a few minutes ago. Can you tell me what you remember about that story now?"

If the subject does not recall the story or having been told a story, make a note as indicated below and SAY: "It was a story about a boy. Can you tell it to me now?"

Maria's / child / Ricky / played / soccer / every / Monday /
at 3:30. / He / liked / going / to the field / behind / their / house /
and joining / the game. / One / day, / he / kicked / the ball / so / hard /
that it / went / over / the neighbor's / fence / where three / large /
dogs / lived. / the dogs' / owner / heard / loud / barking, / came /
out, / and helped / them / retrieve / the ball.

Record time administration began:

Total story units recalled (VERBATIM SCORING): _____ / 44

Total story units recalled (PARAPHRASE SCORING): _____ / 25

Time elapsed since Craft Story 21 Recall (Delayed): _____ minutes

Cue ("boy") needed: ___ No ___ Yes

Reproduced by permission of the author, Suzanne Craft, PhD; do not copy or distribute without author's permission. Form created as part of the Uniform Data Set of the National Alzheimer's Coordinating Center, copyright ©2013 University of Washington

Insert the score in the **MarkVCID e-Case Report Form NP Testing Battery #2b-e Craft Story 21 recall (delayed)**

CRAFT STORY 21 RECALL (DELAYED): VERBATIM SCORING

Maria's	
child	
Ricky	
played	
soccer	
every	
Monday	
three thirty	
he	
liked	
going	
field	
behind	
their	
house	
joining	
game	
one	
day	
he	
kicked	
ball	

so	
hard	
it	
went	
over	
neighbor's	
fence	
three	
large	
dogs	
lived	
dogs'	
owner	
heard	
loud	
barking	
came	
out	
helped	
them	
retrieve	
ball	
TOTAL	

Number of items recalled for **verbatim scoring**: Delayed Recall Score _____/44 maximum

Insert the score in the MarkVCID e-Case Report Form NP Testing Battery #2b Craft Story 21 recall (delayed)

GUIDELINES FOR PARAPHRASE SCORING, CRAFT STORY 21

Item	General rule	Alternative 1-point responses	0-point responses	Points
Maria's	"Maria" or a variant of the name	Mary, Marie	Martha, Anna	
child	"child" or a phrase denoting it was a young person	son, kid, boy, teenager, young man	guy, children, daughter	
Ricky	"Ricky" or a variant of the name	Rick, Rich, Richie, Richard, Ricardo	Randy, Rusty, Robert	
played	"played" is required	to play, plays	did (soccer)	
soccer	"soccer" is required	futbol	baseball, volleyball, other sport	
every Monday	"Monday" or an indication that it occurred on a weekday	—	every day, another day of the week	
at 3:30	an indication that the activity took place in the afternoon	after school, every afternoon	after dinner, at night, in the morning	
He liked going to the field	an indication that he went to an outdoor area	went outside, went to the yard, going to the backyard	went to the school, gym	
behind their house	"house" or word denoting a house	home, residence, where they lived	any other building	
and joining	an indication that he participated in a game	played w/ other kids, became part of the team, playing w/ the team	watching, played in the park	
the game.	"game" in any context	—	—	
One day	"One day" is required	—	—	
he kicked	indication that he performed the activity with his foot	booted, punted	threw, hit (with no mention of the foot)	
the ball	"Ball" is required	football, soccer ball	baseball, volleyball	
so hard	an indication that force was used	so much force, so strongly, (kicked it) so far	—	
that it went over	"Over" is required	—	—	
the neighbor's	an indication that the person lived in the same area	nearby resident	friend's	
fence	"fence" or a word denoting a fence of some kind	garden wall, wall	property line, street	
where three	"Three" is required	three (boys)	—	
large dogs lived.	an indication that there were dogs present	hounds, doggies	puppies, cats, kittens, other animals	
The dogs' owner	an indication that the person was responsible for the dogs	neighbor (if owner implied and "neighbor" mentioned twice)	a bystander, the police	
heard loud barking	an indication that the dogs were making noise	yelping, baying, yapping, heard the dogs	saw the dogs running around	
came out	a word or phrase indicating that the owner was present	(owner) saw the ball	his mother came out, the dogs came out	
and helped them	a word or phrase indicating that help was provided	assisted, aided, had to help	—	
retrieve the ball.	an indication that they got the ball back	gave him the ball, return the ball, (helped him) get the ball —		

Number of items recalled for paraphrase scoring: **Delayed Recall Score: ____/25 maximum**

Insert the score in the **MarkVCID e-Case Report Form NP Testing Battery #2c (craft story 21 recall, delayed)**

Word List Learning with Immediate/Delay/Recognition Worksheets

(Corresponds with CVLT, CVLT-SF, HVL, AVL/RAVL, CERAD, or SEVL (SPANISH))

In general, MarkVCID research sites may choose to administer one of the following word list learning tests: CVLT, CVLT-SF, HVL, AVL/RAVL, CERAD, or SEVL.

The Clinical Assessments In-Person Evaluator’s Manual does NOT contain administration and scoring instructions for these tests. Please contact your site neuropsychologist for the test your site employs and additional instructions specific to your site’s practices.

Note:

For MarkVCID participants co-enrolled in an ADRC, sites are encouraged to conduct either AVL/RAVL or CERAD list-learning task with co-enrolled participants as required by the NACC’s 2025 Uniform Data Set 4.0 updates. Sites should not administer two different list learning tasks to the same individual as this will cause significant participant burden and test interference.¹

For participants *not* co-enrolled in an ADRC, sites are welcome to continue using their current list-learning task.

Insert each score in the MarkVCID e-Case Report Form NP Testing Battery, item #10 (word list learning with immediate/delay/recognition).

¹ Sanderson-Cimino M, Gross AL, Gaynor LS, et al. Development and validation of a harmonized memory score for multicenter Alzheimer’s disease and related dementia research. Preprint. *medRxiv*. 2025;2025.03.31.25324964. Published 2025 Apr 3. doi:10.1101/2025.03.31.25324964

Brief Co-participant/Informant Questionnaire

INSTRUCTIONS: An informant will be used for the CDR, ECog-12 and NPI-Q. This form is to be completed by the intake interviewer in-person, by telephone, or may be completed by the informant by electronic survey.

Co-Participant/Informant Questionnaire

1. What is co-participant's relationship to the subject?

- Spouse, partner, or companion (include ex-spouse, ex-partner, fiancé(e), boyfriend, girlfriend)
- Child (by blood or through marriage or adoption)
- Sibling (by blood or through marriage or adoption)
- Other relative (by blood or through marriage or adoption)
- Friend, neighbor, or someone known through family, friends, work, or community (e.g., church)
- Paid caregiver, health care provider, or clinician

2. How long has the co-participant known the subject? 1 year or less 2-5 years 6-9 years 10 years+

3. Does the co-participant live with the subject? No Yes

3a. If no, approximate frequency of in-person visits?

- Daily
- At least three times per week
- Weekly
- At least three times per month
- Monthly
- Less than once a month

3b. If no, approximate frequency of telephone contact?

- Daily
- At least three times per week
- Weekly
- At least three times per month
- Monthly
- Less than once a month

Clinical Dementia Rating Instructions & Worksheets

Corresponds with NACC Form B4 (UDS 3)

This form is to be completed by the clinician or other trained health professional, based on co-participant report and behavioral and neurological exam of the subject. In the extremely rare instances when no co-participant is available, the clinician or other trained health professional must complete this form using all other available information and his/her best clinical judgment. Score only as decline from previous level due to cognitive loss, not impairment due to other factors, such as physical disability.

SECTION 1: Standard CDR

CDR (CLINICAL DEMENTIA RATING)

Was the CDR administered? No Yes
 If No, please provide the primary reason: Physical problem Verbal refusal
 Cognitive/behavior problem Other problem (specify): _____

Date of Evaluation: ____ / ____ / ____ (MM/DD/YYYY)

Section 1: Standard CDR

Please enter score below:	IMPAIRMENT				
	None – 0	Questionable – 0.5	Mild – 1	Moderate – 2	Severe – 3
1. Memory ____ . ____	No memory loss, or slight inconsistent forgetfulness	Consistent slight forgetfulness; partial recollection of events; “benign” forgetfulness	Moderate memory loss, more marked for recent events; defect interferes with everyday activities	Severe memory loss; only highly learned material retained; new material rapidly lost	Severe memory loss; only fragments remain
2. Orientation ____ . ____	Fully oriented	Fully oriented except for slight difficulty with time relationships	Moderate difficulty with time relationships; oriented for place at examination; may have geographic disorientation elsewhere	Severe difficulty with time relationships; usually disoriented to time, often to place	Oriented to person only
3. Judgment and problem solving ____ . ____	Solves everyday problems, handles business and financial affairs well; judgment good in relation to past performance	Slight impairment in solving problems, similarities, and differences	Moderate difficulty in handling problems, similarities, and differences; social judgment usually maintained	Severely impaired in handling problems, similarities, and differences; social judgment usually impaired	Unable to make judgments or solve problems
4. Community affairs ____ . ____	Independent function at usual level in job, shopping, volunteer and social groups	Slight impairment in these activities	Unable to function independently at these activities, although may still be engaged in some; appears normal to casual inspection	No pretense of independent function outside the home; appears well enough to be taken to functions outside the family home	No pretense of independent function outside the home; appears too ill to be taken to functions outside the family home
5. Home and hobbies ____ . ____	Life at home, hobbies, and intellectual interests well maintained	Life at home, hobbies, and intellectual interests slightly impaired	Mild but definite impairment of function at home; more difficult chores abandoned; more complicated hobbies and interests abandoned	Only simple chores preserved; very restricted interests, poorly maintained	No significant function in the home
6. Personal care ____ . 0	Fully capable of self-care (= 0).		Needs prompting	Requires assistance in dressing, hygiene, keeping of personal effects	Requires much help with personal care; frequent incontinence

7. Auto-calculated Standard CDR Sum of Boxes

8. ____ . ____ STANDARD GLOBAL CDR
 use calculator: <https://www.alz.washington.edu/cdrnacc.html>

CDR SECTION 2:

Section 2: Supplemental CDR					
Please enter score below:	IMPAIRMENT				
	None – 0	Questionable – 0.5	Mild – 1	Moderate – 2	Severe – 3
9. Behavior, comporment, and personality ____ . ____	Socially appropriate behavior	Questionable changes in comporment, empathy, appropriateness of actions	Mild but definite changes in behavior	Moderate behavioral changes, affecting interpersonal relationships and interactions in a significant manner	Severe behavioral changes, making interpersonal interactions all unidirectional
10. Language ____ . ____	No language difficulty, or occasional mild tip-of-the tongue	Consistent mild word-finding difficulties; simplification of word choice; circumlocution; decreased phrase length; and/or mild comprehension difficulties	Moderate word-finding difficulty in speech; cannot name objects in environment; reduced phrase length and/or agrammatical speech and/or reduced comprehension in conversation and reading	Moderate to severe impairments in either speech or comprehension; has difficulty communicating thoughts; writing may be slightly more effective	Severe comprehension deficits; no intelligible speech

Insert each score in the **MarkVCID e-Case Report Form CDR** section.

To calculate the **Standard Global CDR**, please use the following calculator: <https://www.alz.washington.edu/cdrnacc.html>

Enter the Calculated Global CDR in the space provided.

Geriatric Depression Scale (GDS) Worksheet

Corresponds with NACC Form B6 (UDS 3)

Subject ID _____

Date ____/____/____

Examiner's initials _____

Geriatric Depression Scale (short form)

Instructions: Circle the answer that best describes how you felt over the past week.

- | | | |
|---|-----|----|
| 1. Are you basically satisfied with your life? | yes | no |
| 2. Have you dropped many of your activities and interests? | yes | no |
| 3. Do you feel that your life is empty? | yes | no |
| 4. Do you often get bored? | yes | no |
| 5. Are you in good spirits most of the time? | yes | no |
| 6. Are you afraid that something bad is going to happen to you? | yes | no |
| 7. Do you feel happy most of the time? | yes | no |
| 8. Do you often feel helpless? | yes | no |
| 9. Do you prefer to stay at home, rather than going out and doing things? | yes | no |
| 10. Do you feel that you have more problems with memory than most? | yes | no |
| 11. Do you think it is wonderful to be alive now? | yes | no |
| 12. Do you feel worthless the way you are now? | yes | no |
| 13. Do you feel full of energy? | yes | no |
| 14. Do you feel that your situation is hopeless? | yes | no |
| 15. Do you think that most people are better off than you are? | yes | no |

Input the patient's response in the **MarkVCID e-Case Report Form GDS section**. Items will auto-calculate to generate a total score.
Any missing responses will **NOT ALLOW** a total score to be calculated.

Measurement of Everyday Cognition Short Form (ECog-12)

Participant Self Report Worksheet

Subject ID _____ Date _____/_____/_____ Examiner's initials _____

SAY: "Please rate your **CURRENT** ability to perform daily tasks compared with your ability to do the same task **10 years ago**. In other words, try to remember how you were 10 years ago and tell me any changes you have noticed in your ability to do the task. Rate the changes based on the following four-point scale: 1) better or there is no change in my ability compared to 10 years ago 2) I occasionally perform the task worse than 10 years ago, but not all the time 3) I consistently perform the task a little worse than 10 years ago 4) I consistently perform the task much worse than 10 years ago."

(1) Are you worried or believe that you are having problems with their attention, concentration or memory?

- No
 Yes

Compared to 10 years ago, have there been any changes in your ability to....	Better or No Change	Questionable or Occasionally Worse	Consistently or a Little Worse	Consistently Much Worse	Don't Know or N/A
1. Remember where you have placed things (i.e., glasses, keys)?	1 <input type="checkbox"/>	2 <input type="checkbox"/>	3 <input type="checkbox"/>	4 <input type="checkbox"/>	0 <input type="checkbox"/>
2. Remember the current date or day of the week?	1 <input type="checkbox"/>	2 <input type="checkbox"/>	3 <input type="checkbox"/>	4 <input type="checkbox"/>	0 <input type="checkbox"/>
3. Communicate thoughts in a conversation?	1 <input type="checkbox"/>	2 <input type="checkbox"/>	3 <input type="checkbox"/>	4 <input type="checkbox"/>	0 <input type="checkbox"/>
4. Understand spoken directions or instructions?	1 <input type="checkbox"/>	2 <input type="checkbox"/>	3 <input type="checkbox"/>	4 <input type="checkbox"/>	0 <input type="checkbox"/>
5. Read a map and help with directions when someone else is driving?	1 <input type="checkbox"/>	2 <input type="checkbox"/>	3 <input type="checkbox"/>	4 <input type="checkbox"/>	0 <input type="checkbox"/>
6. Find your way around a house/building that you have visited many times?	1 <input type="checkbox"/>	2 <input type="checkbox"/>	3 <input type="checkbox"/>	4 <input type="checkbox"/>	0 <input type="checkbox"/>
7. Anticipate weather changes and planning accordingly?	1 <input type="checkbox"/>	2 <input type="checkbox"/>	3 <input type="checkbox"/>	4 <input type="checkbox"/>	0 <input type="checkbox"/>
8. Thinking ahead?	1 <input type="checkbox"/>	2 <input type="checkbox"/>	3 <input type="checkbox"/>	4 <input type="checkbox"/>	0 <input type="checkbox"/>
9. Keeping your living and workspace organized?	1 <input type="checkbox"/>	2 <input type="checkbox"/>	3 <input type="checkbox"/>	4 <input type="checkbox"/>	0 <input type="checkbox"/>
10. Balancing your checkbook/accounts without error?	1 <input type="checkbox"/>	2 <input type="checkbox"/>	3 <input type="checkbox"/>	4 <input type="checkbox"/>	0 <input type="checkbox"/>
11. Doing two things at once?	1 <input type="checkbox"/>	2 <input type="checkbox"/>	3 <input type="checkbox"/>	4 <input type="checkbox"/>	0 <input type="checkbox"/>
12. Cooking, or working, and talking at the same time?	1 <input type="checkbox"/>	2 <input type="checkbox"/>	3 <input type="checkbox"/>	4 <input type="checkbox"/>	0 <input type="checkbox"/>

Was the ECog-12 Participant Form administered? No Yes

If No, please provide the primary reason:

- Physical problem Verbal refusal Cognitive/behavior problem
 Other problem (specify): _____

Input the patient's response in the **MarkVCID e-Case Report Form ECog-12: Participant** section.

Measurement of Everyday Cognition Short Form (ECog-12)

Informant Worksheet

Subject ID _____ Date ____/____/____ Examiner's initials _____

Please rate the participant's **CURRENT** ability to perform daily tasks compared with their ability to do the same task **10 years ago** (or **since you first knew them** if <10 years). In other words, try to remember how they were 10 years ago and tell me any changes you have noticed in their ability to do the task. Rate the changes based on the following four-point scale: 1) better or there is no change in their ability compared to 10 years ago 2) they occasionally perform the task worse than 10 years ago, but not all the time 3) they consistently perform the task a little worse than 10 years ago 4) they consistently perform the task much worse than 10 years ago

- (1) How long have you known the participant? <10 years At least 10 years
- (2) Are you worried or believe that he/she is having problems with their attention, concentration or memory?
 No Yes

Compared to 10 years ago, have there been any changes in their ability to....	Better or No Change	Questionable or Occasionally Worse	Consistently or a Little Worse	Consistently Much Worse	Don't Know or N/A
13. Remember where they have placed things (i.e., glasses, keys)?	1 <input type="checkbox"/>	2 <input type="checkbox"/>	3 <input type="checkbox"/>	4 <input type="checkbox"/>	0 <input type="checkbox"/>
14. Remember the current date or day of the week?	1 <input type="checkbox"/>	2 <input type="checkbox"/>	3 <input type="checkbox"/>	4 <input type="checkbox"/>	0 <input type="checkbox"/>
15. Communicate thoughts in a conversation?	1 <input type="checkbox"/>	2 <input type="checkbox"/>	3 <input type="checkbox"/>	4 <input type="checkbox"/>	0 <input type="checkbox"/>
16. Understand spoken directions or instructions?	1 <input type="checkbox"/>	2 <input type="checkbox"/>	3 <input type="checkbox"/>	4 <input type="checkbox"/>	0 <input type="checkbox"/>
17. Read a map and help with directions when someone else is driving?	1 <input type="checkbox"/>	2 <input type="checkbox"/>	3 <input type="checkbox"/>	4 <input type="checkbox"/>	0 <input type="checkbox"/>
18. Find their way around a house/building that you have visited many times?	1 <input type="checkbox"/>	2 <input type="checkbox"/>	3 <input type="checkbox"/>	4 <input type="checkbox"/>	0 <input type="checkbox"/>
19. Anticipate weather changes and planning accordingly?	1 <input type="checkbox"/>	2 <input type="checkbox"/>	3 <input type="checkbox"/>	4 <input type="checkbox"/>	0 <input type="checkbox"/>
20. Thinking ahead?	1 <input type="checkbox"/>	2 <input type="checkbox"/>	3 <input type="checkbox"/>	4 <input type="checkbox"/>	0 <input type="checkbox"/>
21. Keeping their living and workspace organized?	1 <input type="checkbox"/>	2 <input type="checkbox"/>	3 <input type="checkbox"/>	4 <input type="checkbox"/>	0 <input type="checkbox"/>
22. Balancing your checkbook/accounts without error?	1 <input type="checkbox"/>	2 <input type="checkbox"/>	3 <input type="checkbox"/>	4 <input type="checkbox"/>	0 <input type="checkbox"/>
23. Doing two things at once?	1 <input type="checkbox"/>	2 <input type="checkbox"/>	3 <input type="checkbox"/>	4 <input type="checkbox"/>	0 <input type="checkbox"/>
24. Cooking, or working, and talking at the same time?	1 <input type="checkbox"/>	2 <input type="checkbox"/>	3 <input type="checkbox"/>	4 <input type="checkbox"/>	0 <input type="checkbox"/>

Was the ECog-12: Informant Form administered? No Yes

If No, please provide the primary reason:

Verbal refusal Informant unavailable (specify below) Other problem (specify below)

Specify reason not administered: _____

Informant/co-participant: Spouse Child Other (specify): _____

Language of test administration: English Spanish Other (specify): _____

Input the patient's response in the **MarkVCID e-Case Report Form ECog:-12 Informant** section.

Neuropsychiatric Inventory-Questionnaire (NPI-Q)

Informant Assessment Worksheet

Subject ID _____

Date ____/____/____

Examiner's initials _____

Instruct the informant: "Please answer the following questions based on changes that have occurred since the patient first began to experience memory (i.e., cognitive) problems. Select 1=Yes only if the symptoms have been present in the last month. Otherwise, select 0=No."

"For each item marked 1=Yes, please rate the SEVERITY of the symptom (i.e., how it affects the patient) according to the following criteria: 1=Mild (noticeable, but not a significant change; 2=Moderate (significant, but not a dramatic change; 3=Severe (very marked or prominent, a dramatic change)."

Question	Yes	No	Unknown	If Yes, Severity
1. Delusions — Does the patient have false beliefs, such as thinking that others are stealing from him/her or planning to harm him/her in some way?	<input type="checkbox"/>	<input type="checkbox"/>	<input type="checkbox"/>	<input type="checkbox"/> Mild <input type="checkbox"/> Moderate <input type="checkbox"/> Severe <input type="checkbox"/> Unknown
2. Hallucinations — Does the patient have hallucinations such as false visions or voices? Does he or she seem to hear or see things that are not present?	<input type="checkbox"/>	<input type="checkbox"/>	<input type="checkbox"/>	<input type="checkbox"/> Mild <input type="checkbox"/> Moderate <input type="checkbox"/> Severe <input type="checkbox"/> Unknown
3. Agitation/aggression — Is the patient resistive to help from others at times, or hard to handle?	<input type="checkbox"/>	<input type="checkbox"/>	<input type="checkbox"/>	<input type="checkbox"/> Mild <input type="checkbox"/> Moderate <input type="checkbox"/> Severe <input type="checkbox"/> Unknown
4. Depression/dysphoria — Does the patient seem sad or say that he/she is depressed?	<input type="checkbox"/>	<input type="checkbox"/>	<input type="checkbox"/>	<input type="checkbox"/> Mild <input type="checkbox"/> Moderate <input type="checkbox"/> Severe <input type="checkbox"/> Unknown
5. Anxiety — Does the patient become upset when separated from you? Does he/she have any other signs of nervousness such as shortness of breath, sighing, being unable to relax, or feeling excessively tense?	<input type="checkbox"/>	<input type="checkbox"/>	<input type="checkbox"/>	<input type="checkbox"/> Mild <input type="checkbox"/> Moderate <input type="checkbox"/> Severe <input type="checkbox"/> Unknown
6. Elation/euphoria — Does the patient appear to feel too good or act excessively happy?	<input type="checkbox"/>	<input type="checkbox"/>	<input type="checkbox"/>	<input type="checkbox"/> Mild <input type="checkbox"/> Moderate <input type="checkbox"/> Severe <input type="checkbox"/> Unknown
7. Apathy/ indifference — Does the patient seem less interested in his/her usual activities or in the activities and plans of others?	<input type="checkbox"/>	<input type="checkbox"/>	<input type="checkbox"/>	<input type="checkbox"/> Mild <input type="checkbox"/> Moderate <input type="checkbox"/> Severe <input type="checkbox"/> Unknown
8. Disinhibition — Does the patient seem to act impulsively, for example, talking to strangers as if he/she knows them, or saying things that may hurt people's feelings?	<input type="checkbox"/>	<input type="checkbox"/>	<input type="checkbox"/>	<input type="checkbox"/> Mild <input type="checkbox"/> Moderate <input type="checkbox"/> Severe <input type="checkbox"/> Unknown
9. Irritability/lability — Is the patient impatient and cranky? Does he/she have difficulty coping with delays or waiting for planned activities?	<input type="checkbox"/>	<input type="checkbox"/>	<input type="checkbox"/>	<input type="checkbox"/> Mild <input type="checkbox"/> Moderate <input type="checkbox"/> Severe <input type="checkbox"/> Unknown
10. Motor disturbance — Does the patient engage in repetitive activities such as pacing around the house, handling buttons, wrapping string, or doing other things repeatedly?	<input type="checkbox"/>	<input type="checkbox"/>	<input type="checkbox"/>	<input type="checkbox"/> Mild <input type="checkbox"/> Moderate <input type="checkbox"/> Severe <input type="checkbox"/> Unknown
11. Nighttime behaviors — Does the patient awaken you during the night, rise too early in the morning, or take excessive naps during the day?	<input type="checkbox"/>	<input type="checkbox"/>	<input type="checkbox"/>	<input type="checkbox"/> Mild <input type="checkbox"/> Moderate <input type="checkbox"/> Severe <input type="checkbox"/> Unknown
12. Appetite/eating — Has the patient lost or gained weight, or had a change in the type of food he/she likes?	<input type="checkbox"/>	<input type="checkbox"/>	<input type="checkbox"/>	<input type="checkbox"/> Mild <input type="checkbox"/> Moderate <input type="checkbox"/> Severe <input type="checkbox"/> Unknown

Was the NPI-Q administered? No Yes

If No, please provide the primary reason:

Verbal refusal Informant unavailable (specify below) Other problem (specify below)

Specify reason not administered: _____

Informant/co-participant: Spouse Child Other (specify): _____

Language of test administration: English Spanish Other (specify): _____

Input the patient's response in the **MarkVCID e-Case Report Form NPI-Q Informant** section.

NACC Functional Assessment Scale (FAS)

Informant Worksheet - Corresponds with NACC Form B7 (UDS 3)²

INSTRUCTIONS: This form is to be completed by the clinician or other trained health professional, based on information provided by the co-participant. Indicate the level of performance for each activity by checking the one appropriate response. The intent of the FAS is to assess change in an individual's functional activities, relative to previously attained abilities, that are caused by cognitive dysfunction. Select the most accurate response, based on the co-participant's assessment.

If the co-participant indicates that the subject no longer performs a particular task, it is reasonable to probe further and ask if they think the subject could still do the task. This will help tease out the relevant cognitive impairment. If the co-participant believes the subject did the activity but cannot speak to the subject's potential changes in that activity, then he/she should select **Unknown**.

In the past four weeks, did the participant have difficulty or need help with:	Not applicable (e.g. never did)	Normal	Has difficulty, but does by self	Requires assistance	Dependent	Unknown
1. Writing checks, paying bills, or balancing a checkbook	<input type="checkbox"/>	<input type="checkbox"/>	<input type="checkbox"/>	<input type="checkbox"/>	<input type="checkbox"/>	<input type="checkbox"/>
2. Assembling tax records, business affairs, or other papers	<input type="checkbox"/>	<input type="checkbox"/>	<input type="checkbox"/>	<input type="checkbox"/>	<input type="checkbox"/>	<input type="checkbox"/>
3. Shopping alone for clothes, household necessities, or groceries	<input type="checkbox"/>	<input type="checkbox"/>	<input type="checkbox"/>	<input type="checkbox"/>	<input type="checkbox"/>	<input type="checkbox"/>
4. Playing a game of skill such as bridge or chess, working on a hobby	<input type="checkbox"/>	<input type="checkbox"/>	<input type="checkbox"/>	<input type="checkbox"/>	<input type="checkbox"/>	<input type="checkbox"/>
5. Heating water, making a cup of coffee, turning off the stove	<input type="checkbox"/>	<input type="checkbox"/>	<input type="checkbox"/>	<input type="checkbox"/>	<input type="checkbox"/>	<input type="checkbox"/>
6. Preparing a balanced meal	<input type="checkbox"/>	<input type="checkbox"/>	<input type="checkbox"/>	<input type="checkbox"/>	<input type="checkbox"/>	<input type="checkbox"/>
7. Keeping track of current events	<input type="checkbox"/>	<input type="checkbox"/>	<input type="checkbox"/>	<input type="checkbox"/>	<input type="checkbox"/>	<input type="checkbox"/>
8. Paying attention to and understanding a TV program, book, or magazine	<input type="checkbox"/>	<input type="checkbox"/>	<input type="checkbox"/>	<input type="checkbox"/>	<input type="checkbox"/>	<input type="checkbox"/>
9. Remembering appointments, family occasions, holidays, medications	<input type="checkbox"/>	<input type="checkbox"/>	<input type="checkbox"/>	<input type="checkbox"/>	<input type="checkbox"/>	<input type="checkbox"/>
10. Traveling out of the neighborhood, driving, or arranging to take public transportation	<input type="checkbox"/>	<input type="checkbox"/>	<input type="checkbox"/>	<input type="checkbox"/>	<input type="checkbox"/>	<input type="checkbox"/>

Was the FAS Form administered? No Yes

If No, please provide the primary reason:

Verbal refusal Informant unavailable (specify below) Other problem (specify below)

Specify reason not administered: _____

Date of Evaluation: ____ / ____ / ____ (MM/DD/YYYY)

Language of test administration: English Spanish Other (specify): _____

Input the patient's response in the **MarkVCID e-Case Report Form FAS** section.

² Adapted from table 4 of Pfeffer RI, Kurosaki TT, Harrah CH, et al. Measurement of functional activities of older adults in the community. J Gerontol 37:323-9, 1982. Copyright 1982. The Gerontological Society of America. Reproduced by permission of the publisher.

Document History

Summary of Changes MarkVCID2 Clinical Assessments Worksheets			
Version	Description of Changes	Reason for Change	Version Date
1.0	N/A – original version	N/A	1.28.22
2.0	<ul style="list-style-type: none">Revised packet to include the Functional Assessment Scale worksheet.Minor revisions to informant form data entry elementsRemoved language for auto-calculating NPI-Q and eCog scores	<ul style="list-style-type: none">Reflect consortium-wide agreement to include the new assessment at remaining study visitsEditorial revisions to make consistent with the data capturing systemClarify the data system does not auto-calculate scores.	5.2.25
3.0	<ul style="list-style-type: none">Revised manual to reflect updated NACC list-learning requirements for co-enrolled ADRC & MarkVCID participants	<ul style="list-style-type: none">Modification of study procedures as needed	7.15.25